

MEMORY

FLASH MEMORY CARD PCMCIA Rel.2/JEIDA Ver.4 conformable

MB98A809Bx-/810Bx-/811Bx-/812Bx-25

FLASH ERASABLE AND PROGRAMMABLE MEMORY CARD 512 K/1 M/2 M/4 M-BYTE

■ DESCRIPTION

The Fujitsu MB98A809Bx, MB98A810Bx, MB98A811Bx and MB98A812Bx are Flash electrically erasable and programmable (Flash) memory cards capable of storing and retrieving large amounts of data. The memory circuits are housed in a credit-card sized 68-pin package. Internal circuit is protected by two metal panels, one at the top and bottom of the card, that help to reduce chip damage from electrostatic discharge.

A unique feature of the Fujitsu memory cards allows the user to organize the card into either an 8-bit or a 16-bit bus configuration. All cards are portable and operate on low power at high speed.

In accordance with the Personal Computer Memory Card International Association (PCMCIA) and Japan Electrical Industry Development Association (JEIDA) industry standard specification, Flash memory cards offer additional EEPROM memory that is used to store attribute data. The attribute memory is a Flash memory card option. (See page 3 for description of the three available options.)

- Credit card size: 85.6 mm (length) × 54.0 mm (width) × 3.3 mm (thick)
- PCMCIA/JEIDA conformed two-piece 68-pin connector (with a two-row built-in receptacle)
- Single +5.0 V ±5% power supply (+12.0 V ±5%V_{PP})
- Command control for Write/Erase operation
- Write protect function

■ PACKAGE

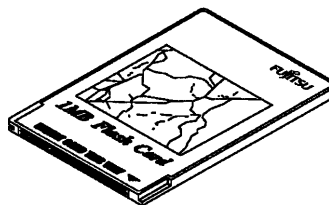

CRD-68P-M17

MB98A809Bx-/810Bx-/811Bx-/812Bx-25

■ ATTRIBUTE MEMORY OPTIONS

PCMCIA and JEIDA standard memory cards from Fujitsu provide a separate EEPROM memory address space for recording fundamental card information. It is used by the card manufacturers to record basic configuration information such as device type, size, speed, etc.

The attribute memory is selected by asserting the $\overline{\text{REG}}$ pin on the card interface. Option descriptions as follows:

OPTION 1: Attribute memory is not supported.

REG Pin: Not Contacted

(JEIDA Ver.3 conformable)

Part Number	Main Memory		Attribute Memory		Memory Organization *
	Memory Device	Access Time	Memory Device	Access Time	
MB98A809B1	2 M Flash Memory × 2 pcs	250 ns	—	—	512 K × 8 bits/256 K × 16 bits
MB98A810B1	2 M Flash Memory × 4 pcs	250 ns	—	—	1 M × 8 bits/512 K × 16 bits
MB98A811B1	2 M Flash Memory × 8 pcs	250 ns	—	—	2 M × 8 bits/1 M × 16 bits
MB98A812B1	2 M Flash Memory × 16 pcs	250 ns	—	—	4 M × 8 bits/2 M × 16 bits

OPTION 2: Attribute memory in a separate location is not supported.

When $\overline{\text{REG}}$ line is asserted, “FF” is output to the data bus to indicate that attribute data may be stored in main memory.

(PCMCIA Rel.2/JEIDA Ver.4 conformable)

Part Number	Main Memory		Attribute Memory		Memory Organization *
	Memory Device	Access Time	Memory Device	Access Time	
MB98A809B2	2 M Flash Memory × 2 pcs	250 ns	—	—	512 K × 8 bits/256 K × 16 bits
MB98A810B2	2 M Flash Memory × 4 pcs	250 ns	—	—	1 M × 8 bits/512 K × 16 bits
MB98A811B2	2 M Flash Memory × 8 pcs	250 ns	—	—	2 M × 8 bits/1 M × 16 bits
MB98A812B2	2 M Flash Memory × 16 pcs	250 ns	—	—	4 M × 8 bits/2 M × 16 bits

OPTION 3: Attribute memory is supported. The data is stored in 16 K-bit EEPROM.

When the $\overline{\text{REG}}$ line is asserted, data stored in EEPROM is output to the data bus.

(PCMCIA Rel.2/JEIDA Ver.4 conformable)

Part Number	Main Memory		Attribute Memory		Memory Organization *
	Memory Device	Access Time	Memory Device	Access Time	
MB98A809B3	2 M Flash Memory × 2 pcs	250 ns	EEPROM × 1 pcs	300 ns	512 K × 8 bits/256 K × 16 bits
MB98A810B3	2 M Flash Memory × 4 pcs	250 ns	EEPROM × 1 pcs	300 ns	1 M × 8 bits/512 K × 16 bits
MB98A811B3	2 M Flash Memory × 8 pcs	250 ns	EEPROM × 1 pcs	300 ns	2 M × 8 bits/1 M × 16 bits
MB98A812B3	2 M Flash Memory × 16 pcs	250 ns	EEPROM × 1 pcs	300 ns	4 M × 8 bits/2 M × 16 bits

* : To be configured by user.

MB98A809Bx-/810Bx-/811Bx-/812Bx-25

Fig. 1 – MB98A809Bx, 810Bx, 811Bx, and 812Bx BLOCK DIAGRAM

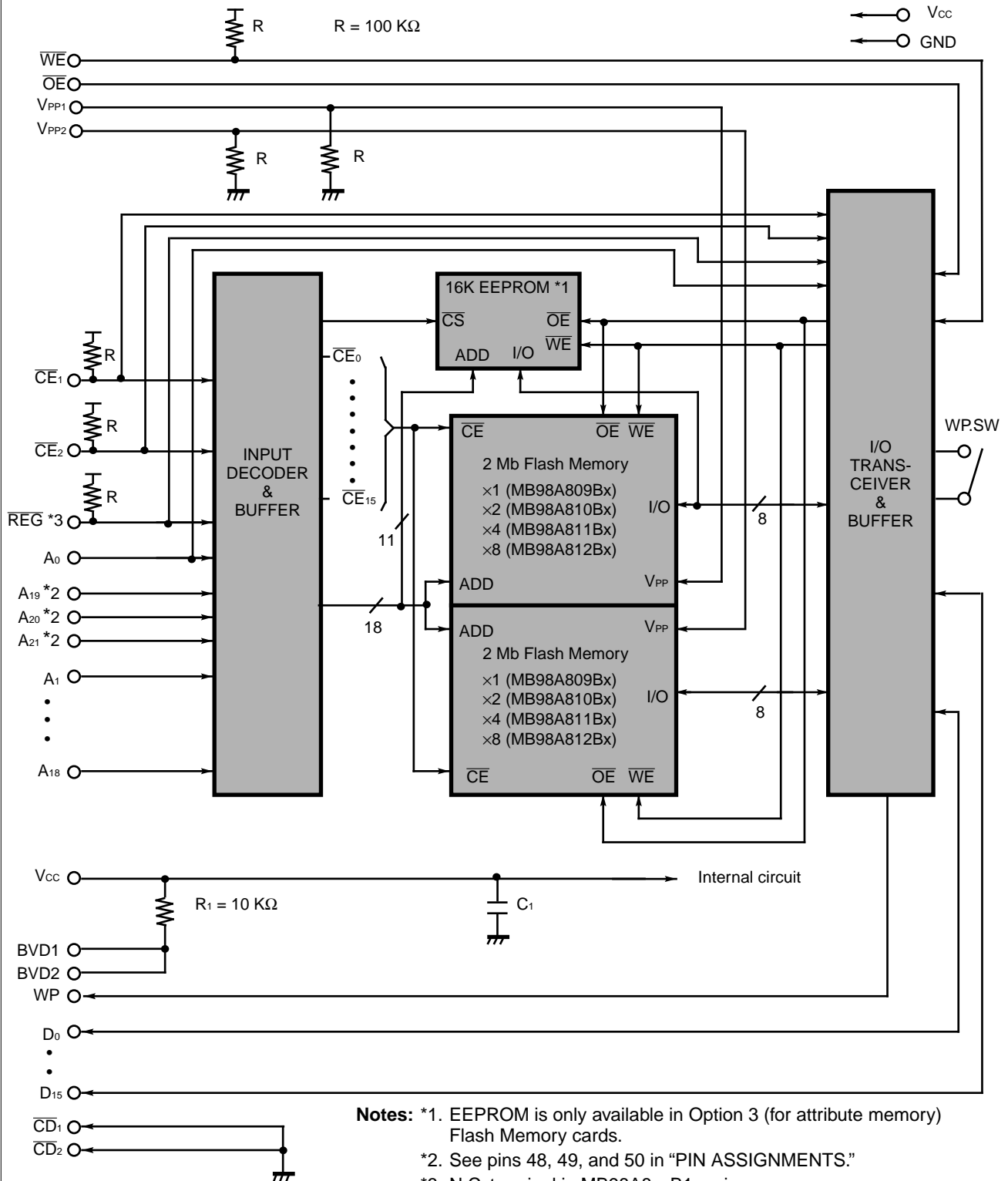

- Notes:** *1. EEPROM is only available in Option 3 (for attribute memory) Flash Memory cards.
 *2. See pins 48, 49, and 50 in "PIN ASSIGNMENTS."
 *3. N.C. terminal in MB98A8xxB1 series.

MB98A809Bx-/810Bx-/811Bx-/812Bx-25

■ PIN ASSIGNMENTS

MB98A809Bx	MB98A810Bx	MB98A811Bx	MB98A812Bx	Pin No.		MB98A809Bx	MB98A810Bx	MB98A811Bx	MB98A812Bx
GND	GND	GND	GND	1	35	GND	GND	GND	GND
D ₃	D ₃	D ₃	D ₃	2	36	\overline{CD}_1	\overline{CD}_1	\overline{CD}_1	\overline{CD}_1
D ₄	D ₄	D ₄	D ₄	3	37	D ₁₁	D ₁₁	D ₁₁	D ₁₁
D ₅	D ₅	D ₅	D ₅	4	38	D ₁₂	D ₁₂	D ₁₂	D ₁₂
D ₆	D ₆	D ₆	D ₆	5	39	D ₁₃	D ₁₃	D ₁₃	D ₁₃
D ₇	D ₇	D ₇	D ₇	6	40	D ₁₄	D ₁₄	D ₁₄	D ₁₄
\overline{CE}_1	\overline{CE}_1	\overline{CE}_1	\overline{CE}_1	7	41	D ₁₅	D ₁₅	D ₁₅	D ₁₅
A ₁₀	A ₁₀	A ₁₀	A ₁₀	8	42	\overline{CE}_2	\overline{CE}_2	\overline{CE}_2	\overline{CE}_2
\overline{OE}	\overline{OE}	\overline{OE}	\overline{OE}	9	43	N.C.	N.C.	N.C.	N.C.
A ₁₁	A ₁₁	A ₁₁	A ₁₁	10	44	N.C.	N.C.	N.C.	N.C.
A ₉	A ₉	A ₉	A ₉	11	45	N.C.	N.C.	N.C.	N.C.
A ₈	A ₈	A ₈	A ₈	12	46	A ₁₇	A ₁₇	A ₁₇	A ₁₇
A ₁₃	A ₁₃	A ₁₃	A ₁₃	13	47	A ₁₈	A ₁₈	A ₁₈	A ₁₈
A ₁₄	A ₁₄	A ₁₄	A ₁₄	14	48	N.C.	A ₁₉	A ₁₉	A ₁₉
\overline{WE}	\overline{WE}	\overline{WE}	\overline{WE}	15	49	N.C.	N.C.	A ₂₀	A ₂₀
N.C.	N.C.	N.C.	N.C.	16	50	N.C.	N.C.	N.C.	A ₂₁
V _{CC}	V _{CC}	V _{CC}	V _{CC}	17	51	V _{CC}	V _{CC}	V _{CC}	V _{CC}
V _{PP1}	V _{PP1}	V _{PP1}	V _{PP1}	18	52	V _{PP2}	V _{PP2}	V _{PP2}	V _{PP2}
A ₁₆	A ₁₆	A ₁₆	A ₁₆	19	53	N.C.	N.C.	N.C.	N.C.
A ₁₅	A ₁₅	A ₁₅	A ₁₅	20	54	N.C.	N.C.	N.C.	N.C.
A ₁₂	A ₁₂	A ₁₂	A ₁₂	21	55	N.C.	N.C.	N.C.	N.C.
A ₇	A ₇	A ₇	A ₇	22	56	N.C.	N.C.	N.C.	N.C.
A ₆	A ₆	A ₆	A ₆	23	57	N.C.	N.C.	N.C.	N.C.
A ₅	A ₅	A ₅	A ₅	24	58	N.C.	N.C.	N.C.	N.C.
A ₄	A ₄	A ₄	A ₄	25	59	N.C.	N.C.	N.C.	N.C.
A ₃	A ₃	A ₃	A ₃	26	60	N.C.	N.C.	N.C.	N.C.
A ₂	A ₂	A ₂	A ₂	27	61	REG/N.C.*	REG/N.C.*	REG/N.C.*	REG/N.C.*
A ₁	A ₁	A ₁	A ₁	28	62	BVD2	BVD2	BVD2	BVD2
A ₀	A ₀	A ₀	A ₀	29	63	BVD1	BVD1	BVD1	BVD1
D ₀	D ₀	D ₀	D ₀	30	64	D ₈	D ₈	D ₈	D ₈
D ₁	D ₁	D ₁	D ₁	31	65	D ₉	D ₉	D ₉	D ₉
D ₂	D ₂	D ₂	D ₂	32	66	D ₁₀	D ₁₀	D ₁₀	D ₁₀
WP	WP	WP	WP	33	67	\overline{CD}_2	\overline{CD}_2	\overline{CD}_2	\overline{CD}_2
GND	GND	GND	GND	34	68	GND	GND	GND	GND

* : N.C. terminal in MB98A8xxB1 series.

MB98A809Bx-/810Bx-/811Bx-/812Bx-25

■ PIN DESCRIPTIONS

Symbol	Pin Name	Input/Output	Function
A ₀ to A ₂₁	Address Input	Input	Address Inputs, A ₀ to A ₂₁ .
D ₀ to D ₁₅	Data Input/Output	Input/Output	Data Inputs/Outputs. This data bus size (8-bit or 16-bit) is selected with \overline{CE}_1 and \overline{CE}_2 .
\overline{CE}_1	Card Enable for Lower Byte	Input	Active Low. - Lower byte (D ₀ to D ₇) is selected for read/write/erase function of flash memory cards.
\overline{CE}_2	Card Enable for Upper Byte	Input	Active Low. - Upper byte (D ₈ to D ₁₅) is selected for read/write / erase function of flash memory cards.
\overline{REG}	Attribute Memory Select	Input	Active Low. - Attribute memory is selected for read/write function of identification data of flash memory cards. (N.C. or "FF" data or attribute data.)
\overline{OE}	Output Enable	Input	Active Low. - Output enable for flash memory cards.
\overline{WE}	Write Enable	Input	Active Low. - Write enable for flash memory cards.
V _{PP1}	Programming Voltage 1	Input	Programming voltage for lower byte.
V _{PP2}	Programming Voltage 2	Input	Programming voltage for upper byte.
$\overline{CD}_1, \overline{CD}_2$	Card Detect	Output	These pins detect if the card has been correctly inserted. Both pins are tied to GND internally.
WP	Write Protect	Output	Write controller for flash memory cards. This pin outputs the Protect/Non Protect status of "WP Switch".
BVD1, BVD2	Battery Voltage Detect	Output	Both pins are tied to V _{CC} internally.
V _{CC}	Power Supply	—	Power Supply Voltage. (+5.0 V ±5%)
GND	Ground	—	System Ground.
N.C.	Non Connection	—	

■ PIN LOCATIONS

Fig. 2 – BOTTOM VIEW (CONNECTOR SIDE)

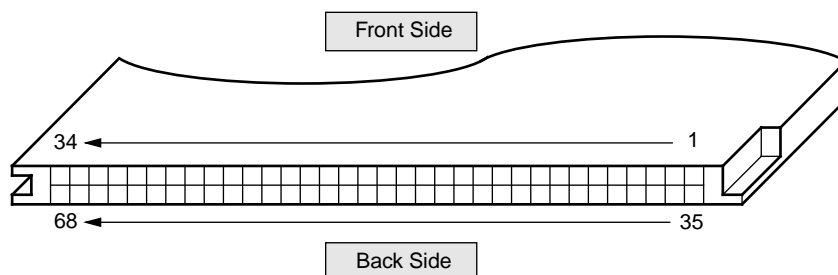

MB98A809Bx-/810Bx-/811Bx-/812Bx-25

FUNCTIONAL TRUTH TABLE

MAIN MEMORY FUNCTION *1

Read Function ($\overline{REG} = V_{IH}$)

\overline{CE}_2	\overline{CE}_1	A_0	\overline{OE}	\overline{WE}	WP *2	V_{PP2}	V_{PP1}	Mode	Data Input/Output		WP SW
									D ₈ to D ₁₅	D ₀ to D ₇	
H	H	X	X	X	X	V_{PPL}	V_{PPL}	Standby	High-Z		P or NP
H	L	L	L	H	X	V_{PPL}	V_{PPL}	Read (×8)	High-Z	D _{OUT} (Lower Byte)	P or NP
H	L	H	L	H	X	V_{PPL}	V_{PPL}	Read (×8)	High-Z	D _{OUT} (Upper Byte)	P or NP
L	H	X	L	H	X	V_{PPL}	V_{PPL}	Read (×8)	D _{OUT} (Upper Byte)	High-Z	P or NP
L	L	X	L	H	X	V_{PPL}	V_{PPL}	Read (×16)	D _{OUT}		P or NP
X	X	X	H	H	X	V_{PPL}	V_{PPL}	Output Disable	High-Z		P or NP

Erase/Write/Verify Function ($\overline{REG} = V_{IH}$)

\overline{CE}_2	\overline{CE}_1	A_0	\overline{OE}	\overline{WE}	WP *2	V_{PP2}	V_{PP1}	Mode	Data Input/Output		WP SW
									D ₈ to D ₁₅	D ₀ to D ₇	
H	H	X	X	X	X	V_{PPH}	V_{PPH}	Standby	High-Z		P or NP
H	L	L	L	H	L	V_{PPL}^*3	V_{PPH}	Read (×8)	High-Z	D _{OUT}	NP
H	L	H	L	H	L	V_{PPH}	V_{PPL}^*3	Read (×8)	High-Z	D _{OUT}	NP
H	L	L	H	L	L	V_{PPL}^*3	V_{PPH}	Write (×8)	High-Z	D _{IN}	NP
H	L	H	H	L	L	V_{PPH}	V_{PPL}^*3	Write (×8)	High-Z	D _{IN}	NP
L	H	X	L	H	L	V_{PPH}	V_{PPL}^*3	Read (×8)	D _{OUT}	High-Z	NP
L	H	X	H	L	L	V_{PPH}	V_{PPL}^*3	Write (×8)	D _{IN}	High-Z	NP
L	L	X	L	H	L	V_{PPH}	V_{PPH}	Read (×16)	D _{OUT}		NP
L	L	X	H	L	L	V_{PPH}	V_{PPH}	Write (×16)	D _{IN}		NP
X	X	X	H	H	L	V_{PPH}	V_{PPH}	Output Disable	High-Z		NP

Notes: *1. H = V_{IH} , L = V_{IL} , X = Either V_{IL} or V_{IH} , WP SW = Write Protect Switch, P = Protect, NP = Non Protect

*2. L-level is output when WPSW = NP. H-level is output when WPSW = P.

*3. V_{PPL} is recommended though it is functionable at V_{PPH} .

MB98A809Bx-/810Bx-/811Bx-/812Bx-25

ATTRIBUTE MEMORY FUNCTION *1 ($\overline{\text{REG}} = V_{\text{IL}}$) *2

$\overline{\text{CE}}_2$	$\overline{\text{CE}}_1$	A_0	$\overline{\text{OE}}$	$\overline{\text{WE}}$	WP	Mode	Data Input/Output		WP SW
							D ₁₅ to D ₈	D ₇ to D ₀	
H	H	X	X	X	L	Standby	High-Z		NP
H	L	L	L	H	L	Read (×8)	High-Z	D _{OUT} *3 (Lower Byte)	NP
H	L	H	L	H	L	Read (×8)	High-Z	H	NP
H	L	L	H	L	L	Write (×8)	High-Z	D _{IN} (Lower Byte)	NP
H	L	H	H	L	L	Write (×8)	High-Z	X	NP
L	H	X	L	H	L	Read (×8)	H	High-Z	NP
L	H	X	H	L	L	Write (×8)	High-Z	High-Z	NP
L	L	X	L	H	L	Read (×16)	H	D _{OUT} *3 (Lower Byte)	NP
L	L	X	H	L	L	Write (×16)	X	D _{IN} (Lower Byte)	NP
X	X	X	H	H	L	Output Disable	High-Z		NP

H	H	X	X	X	H	Standby	High-Z		P
H	L	L	L	H	H	Read (×8)	High-Z	D _{OUT} *3 (Lower Byte)	P
H	L	H	L	H	H	Read (×8)	High-Z	H	P
H	L	L	H	L	H	Output Disable	High-Z		P
H	L	H	H	L	H	Output Disable	High-Z		P
L	H	X	L	H	H	Read (×8)	H	High-Z	P
L	H	X	H	L	H	Output Disable	High-Z		P
L	L	X	L	H	H	Read (×16)	H	D _{OUT} *3 (Lower Byte)	P
L	L	X	H	L	H	Output Disable	High-Z		P
X	X	X	H	H	H	Output Disable	High-Z		P

Notes: *1. H = V_{IH}, L = V_{IL}, X = Either V_{IL} or V_{IH}, WP SW = Write Protect Switch, P = Protect, NP = Non Protect

*2. N.C. for MB98A809B1, 810B1, 811B1, and 812B1.

*3. H-level is output for MB98A809B2, 810B2, 811B2, and 812B2.

MB98A809Bx-/810Bx-/811Bx-/812Bx-25

■ WRITE/ERASE CHIP DECODING INFORMATION

Bus Organization	\overline{CE}_2	\overline{CE}_1	A ₂₀	A ₁₉	A ₁₈	A ₀	Decode Chips				
8-bit Bus	H	L	L	L	L	L	Chip 0				
					H	H	Chip 1				
					L	L	Chip 2				
				H	H	Chip 3					
				L	L	Chip 4					
				H	H	Chip 5					
			H	L	L	L	L	L	Chip 6		
							H	H	Chip 7		
							L	L	Chip 8		
			H	L	H	L	L	H	Chip 9		
							H	L	Chip 10		
							H	H	Chip 11		
						H	L	H	L	L	Chip 12
									H	H	Chip 13
									L	L	Chip 14
	L	H	L	L	L	L	Chip 15				
					H	H	Chip 1				
					L	H	Chip 3				
				H	L	H	L	L	X	Chip 5	
								H	X	Chip 7	
								L	X	Chip 9	
				H	L	H	H	L	X	Chip 11	
								L	X	Chip 13	
								H	X	Chip 15	
16-bit Bus	L	L	L	L	L	X	Chip 0, Chip 1				
					H		Chip 2, Chip 3				
					L		Chip 4, Chip 5				
				H	L		L	Chip 6, Chip 7			
							H	Chip 8, Chip 9			
							L	Chip 10, Chip 11			
			H	L	H		L	L	Chip 12, Chip 13		
								H	Chip 14, Chip 15		
								L			
							H	L	H	L	
										H	
										L	

Note: H = V_{IH}, L = V_{IL}, X = Either V_{IH} or V_{IL}

MB98A809Bx-/810Bx-/811Bx-/812Bx-25

■ COMMAND DEFINITION TABLE

Command Table for 8-bit Mode

Command	Bus Cycle Required	First Bus Cycle			Second Bus Cycle		
		Operation *1	Address *2	Data *3	Operation *1	Address *2	Data *3
Read Memory	1	Write	RA	00H	—	—	—
Read Intelligent ID Codes *4	3	Write	IA	90H	Read	—	—
Set Up Erase/Erase *5	2	Write	ZA	20H	Write	ZA	20H
Erase Verify *5	2	Write	EA	A0H	Read	EA	EVD
Set Up Write/Write *6	2	Write	WA	40H	Write	WA	WD
Write Verify *6	2	Write	WA	C0H	Read	WA	WVD
Reset *7 *8	2	Write	ZA	FFH	Write	ZA	FFH

Command Table for 16-bit Mode

Command	Bus Cycle Required	First Bus Cycle			Second Bus Cycle		
		Operation *1	Address *2	Data *3	Operation *1	Address *2	Data *3
Read Memory	1	Write	RA	0000H	—	—	—
Read Intelligent ID Codes *4	3	Write	IA	9090H	Read	—	—
Set Up Erase/Erase *5	2	Write	ZA	2020H	Write	ZA	2020H
Erase Verify *5	2	Write	EA	A0A0H	Read	EA	EVD
Set Up Write/Write *6	2	Write	WA	4040H	Write	WA	WD
Write Verify *6	2	Write	WA	C0C0H	Read	WA	WVD
Reset *7 *8	2	Write	ZA	FFFFH	Write	ZA	FFFFH

Notes: *1. Bus operations are defined in "FUNCTIONAL TRUTH TABLE".

*2. IA = Identifier address: 00H for manufacturer code, 01H for device code.

EA = Address of memory location to be read during erase verify.

RA = Read Address

WA = Address of memory location to be written.

ZA = Address of 256 K-Byte zones involved in erase operation.

Addresses are latched on the falling edge of the Write Enable pulse.

*3. ID = Data read from location IA during device identification.

Manufacturer = 31H for 8-bit, 3131H for 16-bit/Device = BDH for 8-bit, BDBDH for 16-bit

EVD = Data read from location EA during erase verify.

WD = Data to be programmed at location WA. Data is latched on the rising edge of Write Enable.

WVD = Data read from location WA during write verify. WA is latched on the Write command.

*4. Following the Read Intelligent ID command, two read operations access manufacturer and device codes.

*5. "ERASE FLOWCHART" in Fig.6, Fig.7 and Fig.8 illustrate the Erase Algorithm.

*6. "WRITE FLOWCHART" in Fig.4 and Fig.5 illustrate the Write Algorithm.

*7. The second bus cycle must be followed by the desired command register write.

*8. The Reset command operates on a zone basis. To reset the entire card requires reset write cycles to each zone.

MB98A809Bx-/810Bx-/811Bx-/812Bx-25

■ ADDRESS CONFIGURATIONS *1 (MAIN MEMORY)

8-BIT BUS ORGANIZATION ($\overline{CE}_1 = V_{IL}$, $\overline{CE}_2 = V_{IH}$)

A ₂₁ to A ₀						\overline{CE}_2	\overline{CE}_1	D ₁₅ to D ₈	D ₇ to D ₀
00	0000	0000	0000	0000	0000	H	L	-----	0 Add.
00	0000	0000	0000	0000	0001	H	L	-----	1 Add.
00	0000	0000	0000	0000	0010	H	L	-----	2 Add.
00	0000	0000	0000	0000	0011	H	L	-----	3 Add.
↓	↓	↓	↓	↓	↓	↓	↓	↓ ↓	↓ ↓
11	1111	1111	1111	1111	1100	H	L	-----	4,194,300 Add.
11	1111	1111	1111	1111	1101	H	L	-----	4,194,301 Add.
11	1111	1111	1111	1111	1110	H	L	-----	4,194,302 Add.
11	1111	1111	1111	1111	1111	H	L	-----	4,194,303 Add.

8-BIT BUS ORGANIZATION ($\overline{CE}_1 = V_{IH}$, $\overline{CE}_2 = V_{IL}$) *2

A ₂₁ to A ₀						\overline{CE}_2	\overline{CE}_1	D ₁₅ to D ₈	D ₇ to D ₀
00	0000	0000	0000	0000	000X	L	H	1 Add.	-----
00	0000	0000	0000	0000	001X	L	H	3 Add.	-----
00	0000	0000	0000	0000	010X	L	H	5 Add.	-----
00	0000	0000	0000	0000	011X	L	H	7 Add.	-----
↓	↓	↓	↓	↓	↓	↓	↓	↓ ↓	↓ ↓
11	1111	1111	1111	1111	100X	L	H	4,194,297 Add.	-----
11	1111	1111	1111	1111	101X	L	H	4,194,299 Add.	-----
11	1111	1111	1111	1111	110X	L	H	4,194,301 Add.	-----
11	1111	1111	1111	1111	111X	L	H	4,194,303 Add.	-----

16-BIT BUS ORGANIZATION ($\overline{CE}_1 = V_{IL}$, $\overline{CE}_2 = V_{IL}$)

A ₂₁ to A ₀						\overline{CE}_2	\overline{CE}_1	D ₁₅ to D ₈	D ₇ to D ₀
00	0000	0000	0000	0000	000X	L	L	1 Add.	0 Add.
00	0000	0000	0000	0000	001X	L	L	3 Add.	2 Add.
00	0000	0000	0000	0000	010X	L	L	5 Add.	4 Add.
00	0000	0000	0000	0000	011X	L	L	7 Add.	6 Add.
↓	↓	↓	↓	↓	↓	↓	↓	↓ ↓	↓ ↓
11	1111	1111	1111	1111	100X	L	L	4,194,297 Add.	4,194,296 Add.
11	1111	1111	1111	1111	101X	L	L	4,194,299 Add.	4,194,298 Add.
11	1111	1111	1111	1111	110X	L	L	4,194,301 Add.	4,194,300 Add.
11	1111	1111	1111	1111	111X	L	L	4,194,303 Add.	4,194,302 Add.

Notes: *1. H = V_{IH}, L = V_{IL}, X = Either 0 or 1.

*2. Even addresses are not available in this mode.

MB98A809Bx-/810Bx-/811Bx-/812Bx-25

■ ABSOLUTE MAXIMUM RATINGS (See WARNING)

Parameter	Note	Symbol	Value	Unit
Supply Voltage		V_{CC}	-0.5 to +6.0	V
Input Voltage		V_{IN}	-0.5 to $V_{CC} + 0.5$	V
Output Voltage		V_{OUT}	-0.5 to $V_{CC} + 0.5$	V
Programming Voltage	*1	V_{PP1}, V_{PP2}	-2.0 to +14.0	V
Storage Temperature at turning on the power		T_{BIAS}	-10 to 70	°C
Ambient Temperature		T_A	0 to +60	°C
Storage Temperature		T_{STG}	-30 to +70	°C

Note: *1. Minimum DC input voltage is -0.5 V.

WARNING: Semiconductor devices can be permanently damaged by application of stress (voltage, current, temperature, etc.) in excess of absolute maximum ratings. Do not exceed these ratings.

■ RECOMMENDED OPERATING CONDITIONS

Parameter	Symbol	Min.	Typ.	Max.	Unit
V_{CC} Supply Voltage	V_{CC}	4.75	5.0	5.25	V
Ground	GND	—	0	—	V
Ambient Temperature	T_A	0	—	+55	°C

WARNING: Recommended operating conditions are normal operating ranges for the semiconductor device. All the device's electrical characteristics are warranted when operated within these ranges.

Always use semiconductor devices within the recommended operating conditions. Operation outside these ranges may adversely affect reliability and could result in device failure.

No warranty is made with respect to uses, operating conditions, or combinations not represented on the data sheet. Users considering application outside the listed conditions are advised to contact their FUJITSU representative beforehand.

MB98A809Bx-/810Bx-/811Bx-/812Bx-25

■ CAPACITANCE

($T_A = 25^\circ\text{C}$, $f = 1\text{ MHz}$, $V_{\text{IN}} = V_{\text{I/O}} = \text{GND}$)

Parameter	Notes	Symbol	Min.	Max.	Unit
Input Capacitance	*1	C_{IN}	—	50	pF
I/O Capacitance	*2	$C_{\text{I/O}}$	—	50	pF

Notes: *1. This value does not apply to $\overline{\text{CE}}_1$, $\overline{\text{CE}}_2$, $\overline{\text{WE}}$ and $\overline{\text{REG}}$.

*2. This value does not apply to $\overline{\text{CE}}_1$, $\overline{\text{CE}}_2$, BVD1 and BVD2.

Fig. 3 – AC TEST CONDITIONS

• Output Load

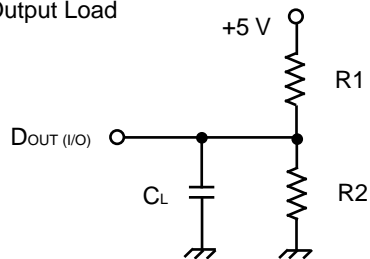

- Input Pulse Levels: 0.6 V to 2.6 V
 - Input Pulse Rise and Fall Times: 5 ns (Transient between 0.8 V and 2.4 V)
 - Timing Reference Levels
Input: $V_{\text{IL}} = 0.8\text{ V}$, $V_{\text{IH}} = 2.4\text{ V}$
Output: $V_{\text{OL}} = 0.8\text{ V}$, $V_{\text{OH}} = 2.0\text{ V}$
- * Including jig and stray capacitance

	R1	R2	CL	Parameter Measured
Load I	1.8 k Ω	990 Ω	100 pF	All parameters except t_{CLZ} , t_{OLZ} , t_{EHQZ} , t_{DF} , t_{RCLZ} , t_{ROLZ} , t_{RCHZ} and t_{ROHZ}
Load II	1.8 k Ω	990 Ω	5 pF	t_{CLZ} , t_{OLZ} , t_{EHQZ} , t_{DF} , t_{RCLZ} , t_{ROLZ} , t_{RCHZ} and t_{ROHZ}

MB98A809Bx-/810Bx-/811Bx-/812Bx-25

■ DC CHARACTERISTICS

Parameter	Notes	Symbol	Condition	Value			Unit
				Min.	Typ.	Max.	
Input Leakage Current	*1	I_{LI}	$V_{CC} = V_{CC\ max}$ $V_{IN} = 0\ V\ or\ V_{CC}$	—	± 1.0	± 20	μA
Output Leakage Current	*2	I_{LO}	$V_{CC} = V_{CC\ max}$ $V_{IN} = 0\ V\ or\ V_{CC}$	—	± 1.0	± 20	μA
V_{CC} Standby Current		I_{SB1}	$V_{CC} = V_{CC\ max}$ $\overline{CE}_1 = \overline{CE}_2 = V_{CC} - 0.2\ V$	—	0.9	1.7	mA
		I_{SB2}	$V_{CC} = V_{CC\ max}$ $\overline{CE}_1 = \overline{CE}_2 = V_{IH}$	—	7.0	140.	mA
V_{CC} Active Read Current		I_{CC1}	$V_{CC} = V_{CC\ max}$ $\overline{CE}_1 = \overline{CE}_2 = V_{IL}$ cyc. = 250 ns, $I_{OUT} = 0\ mA$	—	70	100	mA
V_{CC} Write Current		I_{CC2}	Write in progress	—	2.0	20	mA
V_{CC} Erase Current		I_{CC3}	Erase in progress	—	10	30	mA
V_{PP} Leakage Current	*3	I_{PPS}	$V_{PP} \leq V_{CC}$	—	—	250	μA
V_{PP} Read Current or Standby Current	*3	I_{PP1}	$V_{PP} > V_{CC}$	—	0.9	1.8	mA
			$V_{PP} \leq V_{CC}$	—	—	250	mA
V_{PP} Write Current	*3	I_{PP2}	$V_{PP} = V_{PPH}$ Write in progress	—	9	30	mA
V_{PP} Erase Current	*3	I_{PP3}	$V_{PP} = V_{PPH}$ Erase in progress	—	7	30	mA
Input Low Voltage		V_{IL}	—	-0.3	—	0.8	V
Input High Voltage		V_{IH}	—	2.4	—	$V_{CC} + 0.3$	V
Output Low Voltage		V_{OL}	$I_{OL} = 3.2\ mA$, $V_{CC} = V_{CC\ min}$	—	—	0.4	V
Output High Voltage	*4	V_{OH}	$I_{OH} = -2.0\ mA$, $V_{CC} = V_{CC\ min}$	3.8	—	—	V
V_{PP} during Read-Only Operation	*5	V_{PPL}	—	0	—	6.5	V
V_{PP} during Write/Erase Operation		V_{PPH}	—	11.4	—	12.6	V

Notes: *1. This value does not apply to \overline{CE}_1 , \overline{CE}_2 , \overline{WE} and \overline{REG} .

*2. This value does not apply to BVD1, BVD2, \overline{CD}_1 and \overline{CD}_2 .

*3. This value apply to V_{PP1} and V_{PP2} .

*4. This value does not apply to BVD1 and BVD2.

*5. Write/Erase are inhibited when $V_{PP} = V_{PPL}$.

MB98A809Bx-/810Bx-/811Bx-/812Bx-25

■ AC CHARACTERISTICS

(At recommended operating conditions unless otherwise noted.)

MAIN MEMORY READ CYCLE *1

Parameter	Notes	Symbol	Min.	Max.	Unit
Read Cycle Time		t_{RC}	250	—	ns
Card Enable Access Time		t_{CE}	—	250	ns
Address Access Time		t_{ACC}	—	250	ns
Output Enable Access Time		t_{OE}	—	120	ns
Card Enable to Output in Low-Z	*2	t_{CLZ}	5	—	ns
Card Disable to Output in High-Z	*2	t_{EHQZ}	—	60	ns
Output Enable to Output in Low-Z	*2	t_{OLZ}	5	—	ns
Output Disable to Output in High-Z	*2	t_{DF}	—	60	ns
Output Hold from Address, \overline{CE} , or \overline{OE} Change	*3	t_{OH}	5	—	ns

ATTRIBUTE MEMORY READ CYCLE *1*4

Parameter	Notes	Symbol	Min.	Max.	Unit
Read Cycle Time		t_{RRC}	300	—	ns
Address Access Time		t_{RAA}	—	300	ns
Card Enable Access Time		t_{RCE}	—	300	ns
Output Enable Access Time		t_{ROE}	—	150	ns
Output Hold from Address Change		t_{ROH}	5	—	ns
Card Enable to Output Low-Z	*2	t_{RCLZ}	5	—	ns
Output Enable to Output Low-Z	*2	t_{ROLZ}	5	—	ns
Card Enable to Output High-Z	*2	t_{RCHZ}	—	60	ns
Output Enable to Output High-Z	*2	t_{ROHZ}	—	60	ns

Notes: *1. Rise/Fall time < 5 ns.

*2. Transition is measured at the point of ± 500 mV from steady state voltage. This parameter is specified using Load II in Fig.3.

*3. This parameter is specified from the rising edge of \overline{OE} , \overline{CE}_1 and \overline{CE}_2 , whichever occurs first.

*4. This parameter is for MB98A809B3, 810B3, 811B3, and 812B3.

MB98A809Bx-/810Bx-/811Bx-/812Bx-25

MAIN MEMORY READ CYCLE TIMING DIAGRAM ($\overline{WE} = V_{IH}$, $\overline{REG} = V_{IH}$)

READ CYCLE 1: $\overline{CE}_1 = \overline{OE} = V_{IL}$, $\overline{CE}_2 = V_{IH}$: × 8-bit Bus Organization

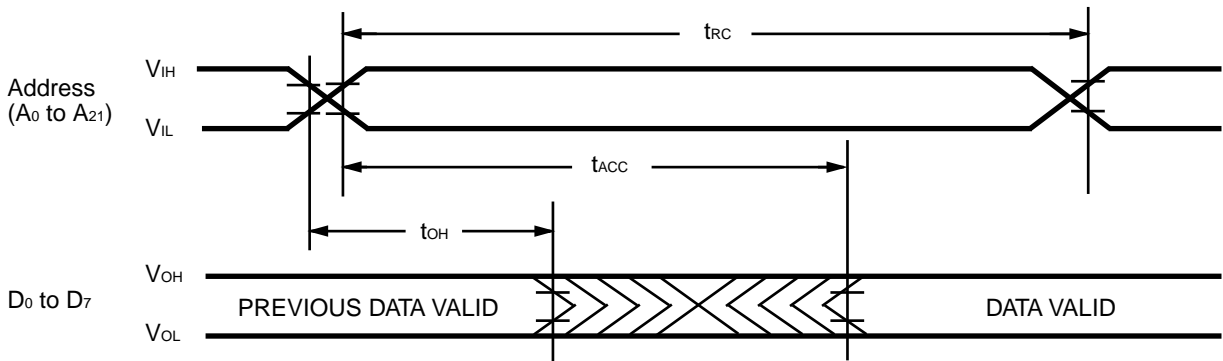

READ CYCLE 2: $\overline{CE}_1 = V_{IH}$, $\overline{CE}_2 = \overline{OE} = V_{IL}$: × 8-bit Bus Organization
 $\overline{CE}_1 = \overline{CE}_2 = \overline{OE} = V_{IL}$: × 16-bit Bus Organization

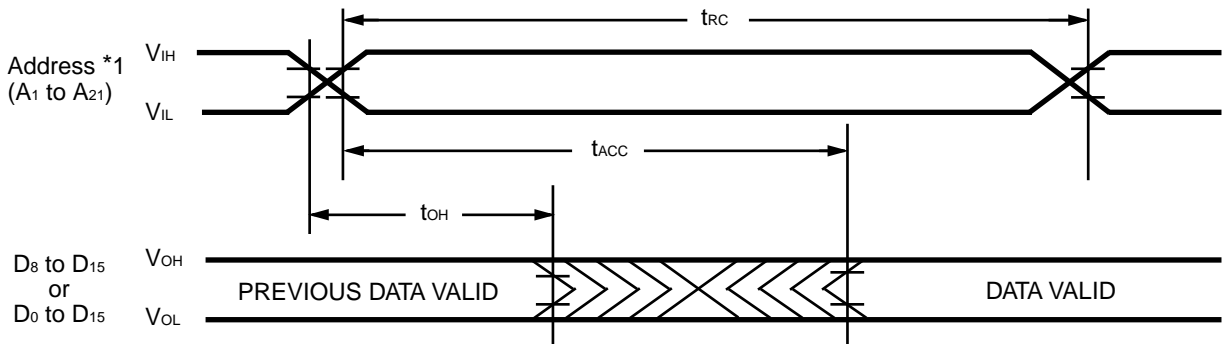

 : Undefined

Note: *1. A₀ = Either V_{IH} or V_{IL}.

MB98A809Bx-/810Bx-/811Bx-/812Bx-25

MAIN MEMORY READ CYCLE TIMING DIAGRAM ($\overline{WE} = V_{IH}$, $\overline{REG} = V_{IH}$)

READ CYCLE 3: $\overline{CE}_2 = V_{IH}$: × 8-bit Bus Organization

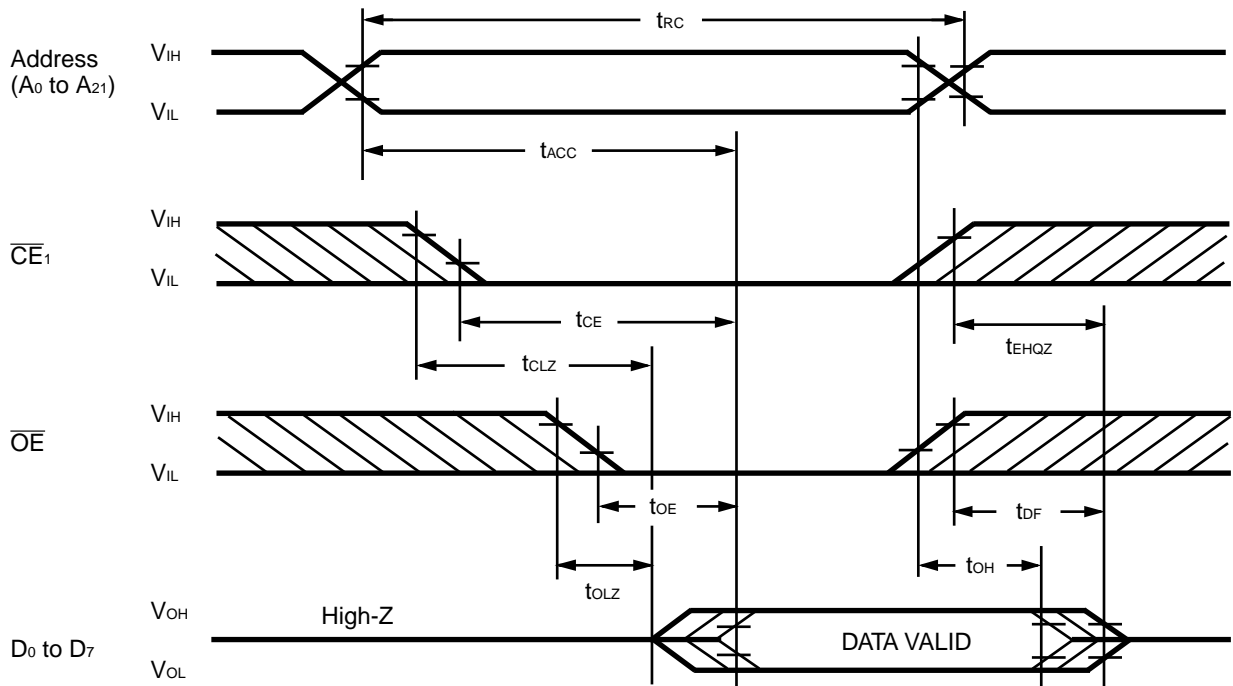

 : Undefined

MB98A809Bx-/810Bx-/811Bx-/812Bx-25

MAIN MEMORY READ CYCLE TIMING DIAGRAM ($\overline{WE} = V_{IH}$, $\overline{REG} = V_{IH}$)

READ CYCLE 4: $\overline{CE}_1 = V_{IH}$: × 8-bit Bus Organization

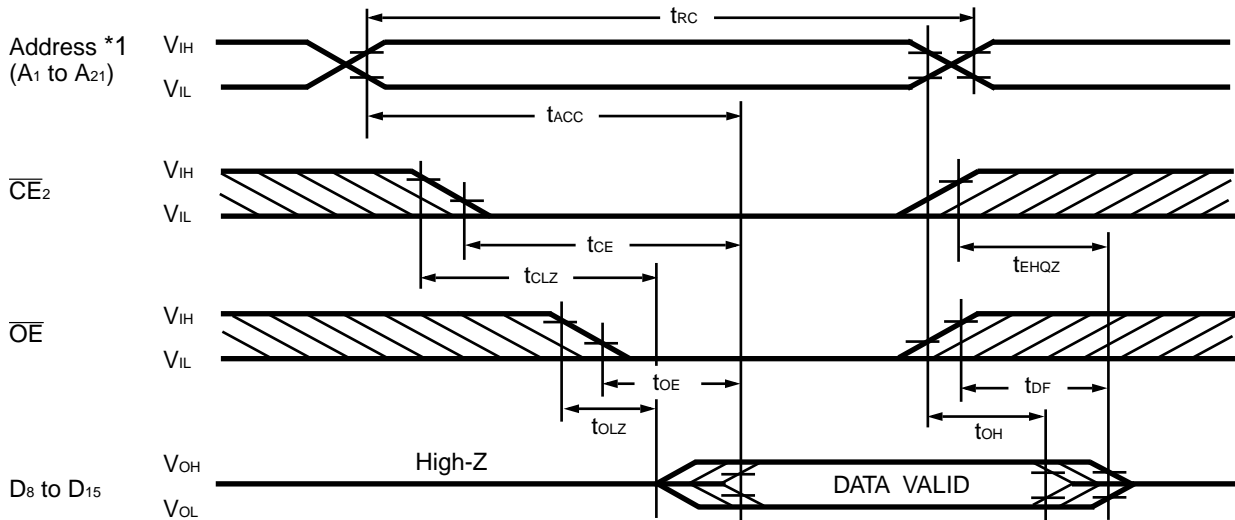

READ CYCLE 5: $\overline{CE}_1 = \overline{CE}_2 = V_{IL}$: × 16-bit Bus Organization

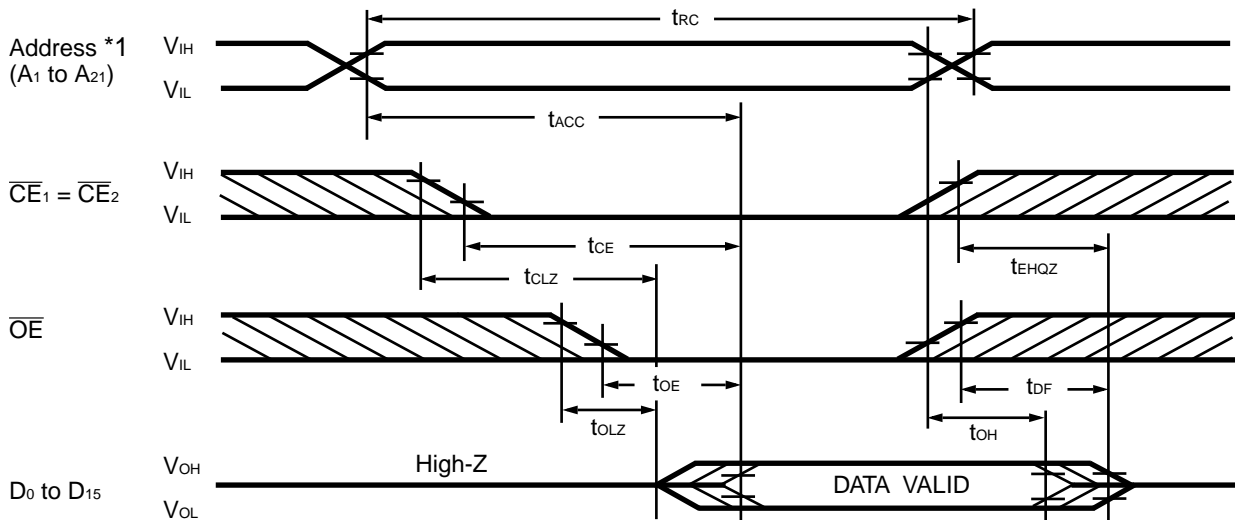

 : Undefined

Note: *1. $A_0 =$ Either V_{IL} or V_{IH} .

MB98A809Bx-/810Bx-/811Bx-/812Bx-25

ATTRIBUTE MEMORY READ CYCLE TIMING DIAGRAM ($\overline{WE} = V_{IH}$, $\overline{REG} = V_{IL}$) *1

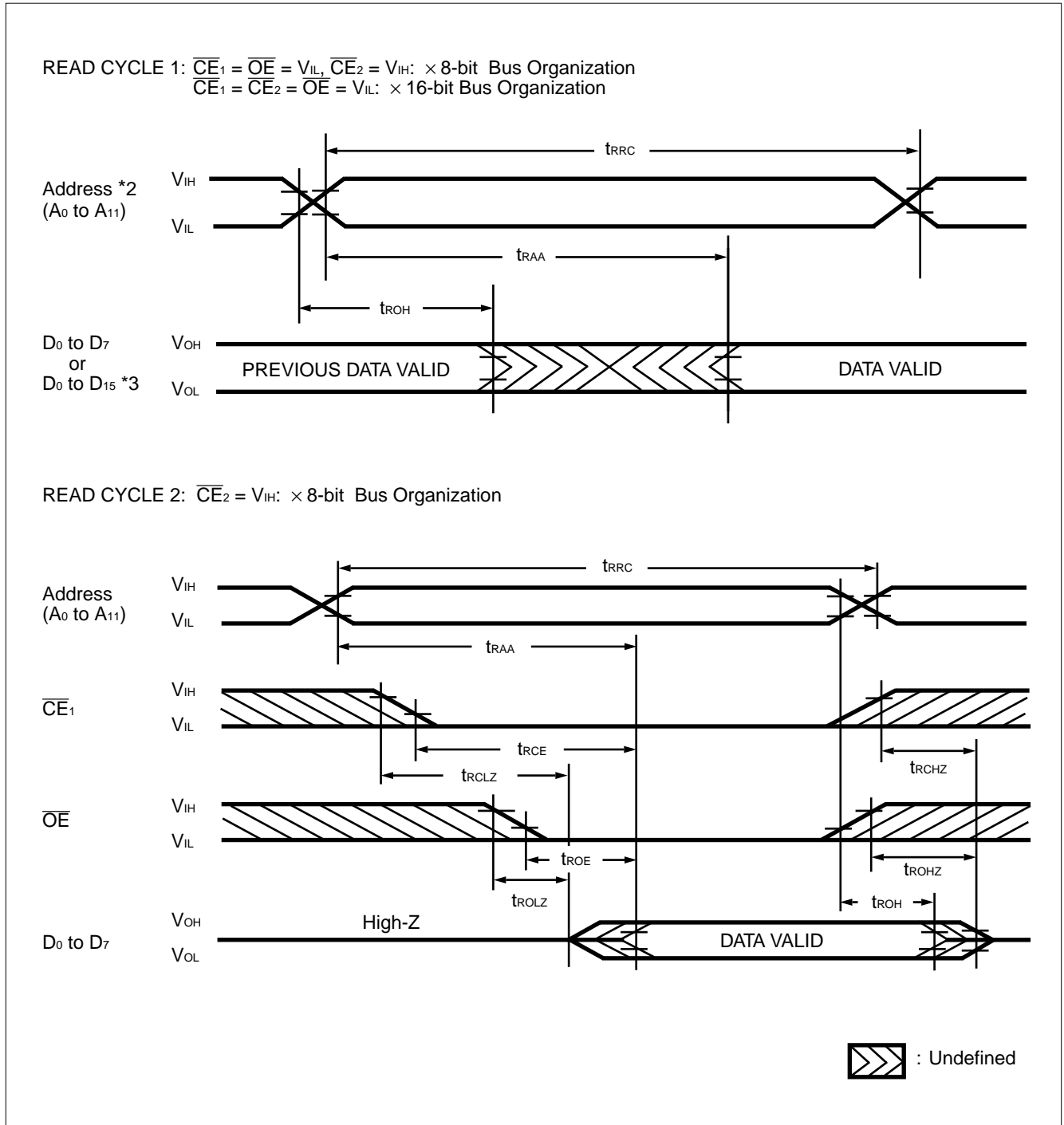

Notes: *1. This timing diagram is for MB98A809B3, 810B3, 811B3, and 812B3. "FF" data is available on MB98A809B2, 810B2, 811B2, and 812B2 only.

*2. A₀ = Either V_{IH} or V_{IL} during 16 bits bus organization.

*3. H-level is output from D₈ to D₁₅.

MB98A809Bx-/810Bx-/811Bx-/812Bx-25

ATTRIBUTE MEMORY READ CYCLE TIMING DIAGRAM ($\overline{WE} = V_{IH}$, $\overline{REG} = V_{IL}$) *1

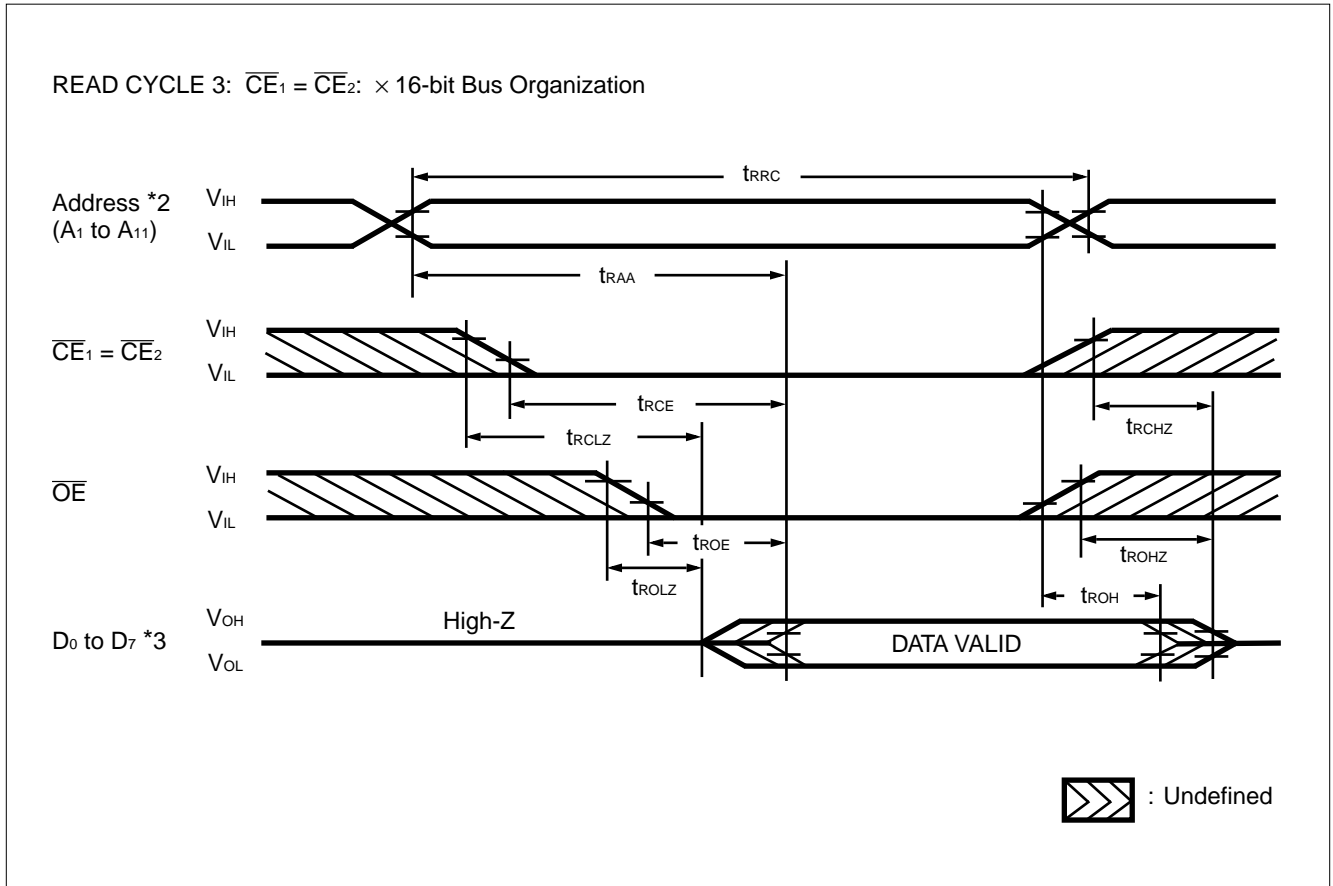

Notes: *1. This timing diagram is for MB98A809B3, 810B3, 811B3, and 812B3. "FF" data is available on MB98A809B2, 810B2, 811B2, and 812B2 only.

*2. A₀ = Either V_{IH} or V_{IL}.

*3. H-level is output from D₈ to D₁₅.

MB98A809Bx-/810Bx-/811Bx-/812Bx-25

MAIN MEMORY WRITE/ERASE CYCLE *1

Parameter	Notes	Symbol	Min.	Max.	Unit
Write Cycle Time		t _{WC}	250	—	ns
Address Set Up Time		t _{AS}	0	—	ns
Address Hold Time		t _{AH}	100	—	ns
Data Set Up Time		t _{DS}	80	—	ns
Data Hold Time		t _{DH}	30	—	ns
Write Recovery Time before Read		t _{WHGL}	6	—	μs
Read Recovery Time before Write		t _{GHWL}	0	—	μs
Card Enable Set Up Time before Write		t _{CS}	40	—	ns
Card Enable Hold Time		t _{CH}	0	—	ns
Write Enable Pulse Width		t _{WP}	100	—	ns
Write Enable Pulse Width High		t _{WPH}	60	—	ns
Write Enable Set Up Time		t _{WS}	0	—	ns
Write Enable Hold Time		t _{WH}	0	—	ns
Card Enable Pulse Width		t _{CP}	140	—	ns
Card Enable Pulse Width High		t _{CPH}	60	—	ns
Duration of Write Operation	*3	t _{WHWH1}	10	—	μs
Duration of Erase Operation	*3	t _{WHWH2}	9.5	—	ms
V _{PP} Set Up Time to Chip Enable Low		t _{VPEL}	1.0	—	μs

Notes: *1. Read timing parameters during Write/Erase operations are the same as during read only operations. Refer to AC characteristics for Main Memory Read Cycle.

*2. Rise/Fall time ≤ 5 ns.

*3. The integrated stop timer terminates the Write/Erase operations, thereby eliminating the need for a maximum specification.

MB98A809Bx-/810Bx-/811Bx-/812Bx-25

MAIN MEMORY WRITE/ERASE PERFORMANCE *1

Rating	Notes	Min.	Typ.	Max.	Unit
Chip Erase Time	*1	—	2.0 *2	30	Sec.
Chip Write Time		—	4.0 *2	25 *3	Sec.
Write/Erase Cycle		100,000	100,000	—	Cycle

Notes: *1. Excludes 00H writing prior to Erasure.

*2. $T_A = 25^\circ\text{C}$, $V_{PP} = 12\text{ V}$, 100,000 Cycles.

ATTRIBUTE MEMORY WRITE CYCLE *1

Parameter	Symbol	Min.	Max.	Unit
Write Cycle Time	t_{RWR}	—	10	ms
Address Set Up Time	t_{RAS}	20	—	ns
Card Enable Set Up Time	t_{RCS}	0	—	ns
Output Enable Set Up Time	t_{ROES}	20	—	ns
Write Pulse Width	t_{RWP}	100	—	ns
Address Hold Time	t_{RAH}	50	—	ns
Data Set Up Time	t_{RDS}	50	—	ns
Data Hold Time	t_{RDH}	20	—	ns
Card Enable Hold Time	t_{RCH}	0	—	ns
Output Enable Hold Time	t_{ROEH}	20	—	ns
Write Recovery Time	t_{RRE}	50	—	ns
End of Write to Output Time	t_{RRBO}	—	100	ns
Number of Write per Byte	N	10000	—	Times
Write Enable Hold Time	t_{RWEH}	10	—	ns

Note: *1. This parameter is for MB98A809B3, 810B3, 811B3, and 812B3.

MB98A809Bx-/810Bx-/811Bx-/812Bx-25

MAIN MEMORY WRITE CYCLE TIMING DIAGRAM (\overline{WE} = CONTROLLED) *1

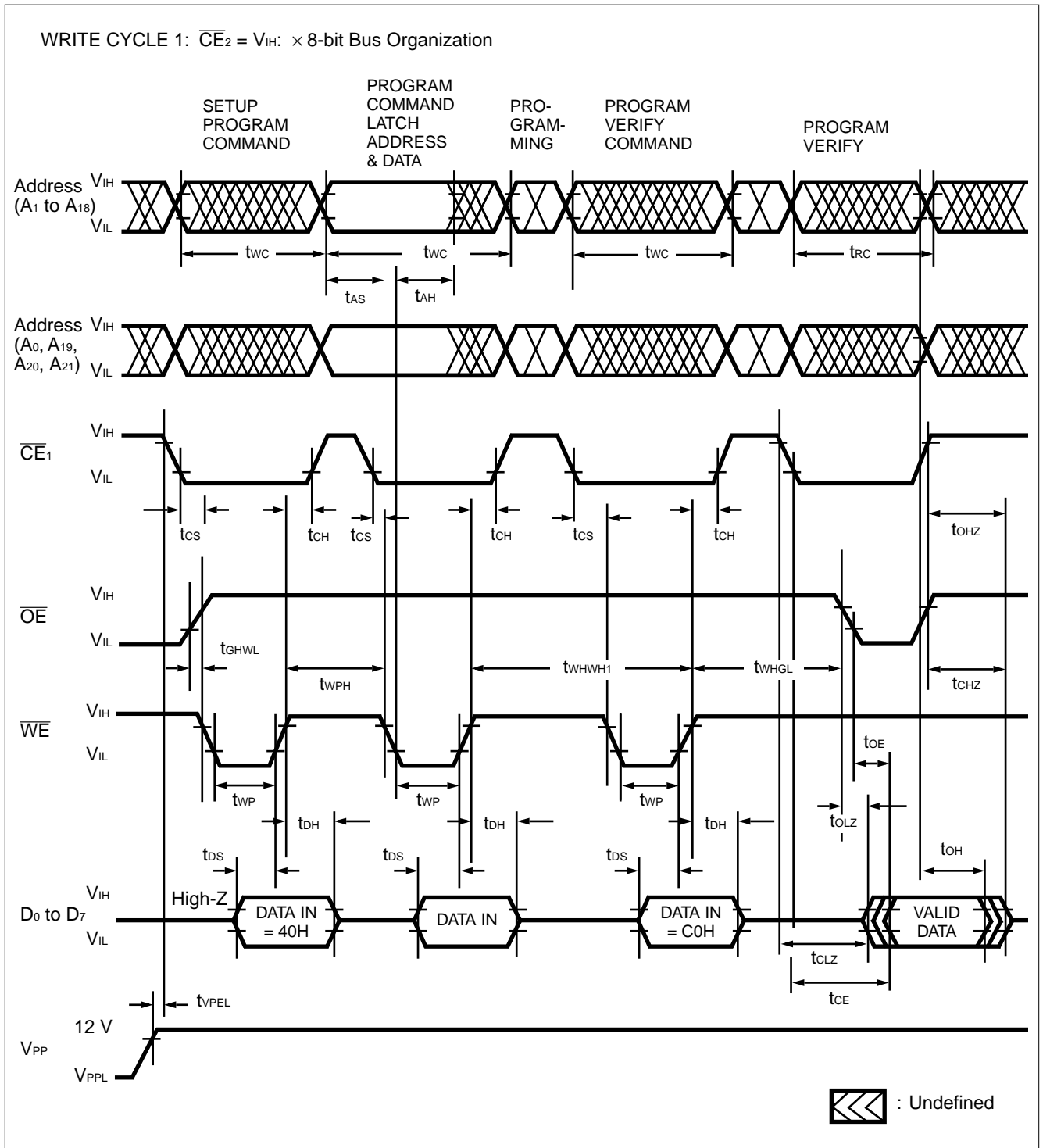

Note: *1. A_0, A_{19}, A_{20} and A_{21} have to be fixed during programming command input because these addresses are chip decoding addresses. Refer to the WRITE/ERASE CHIP DECODING INFORMATION.

MB98A809Bx-/810Bx-/811Bx-/812Bx-25

MAIN MEMORY WRITE CYCLE TIMING DIAGRAM (\overline{WE} = CONTROLLED) *1

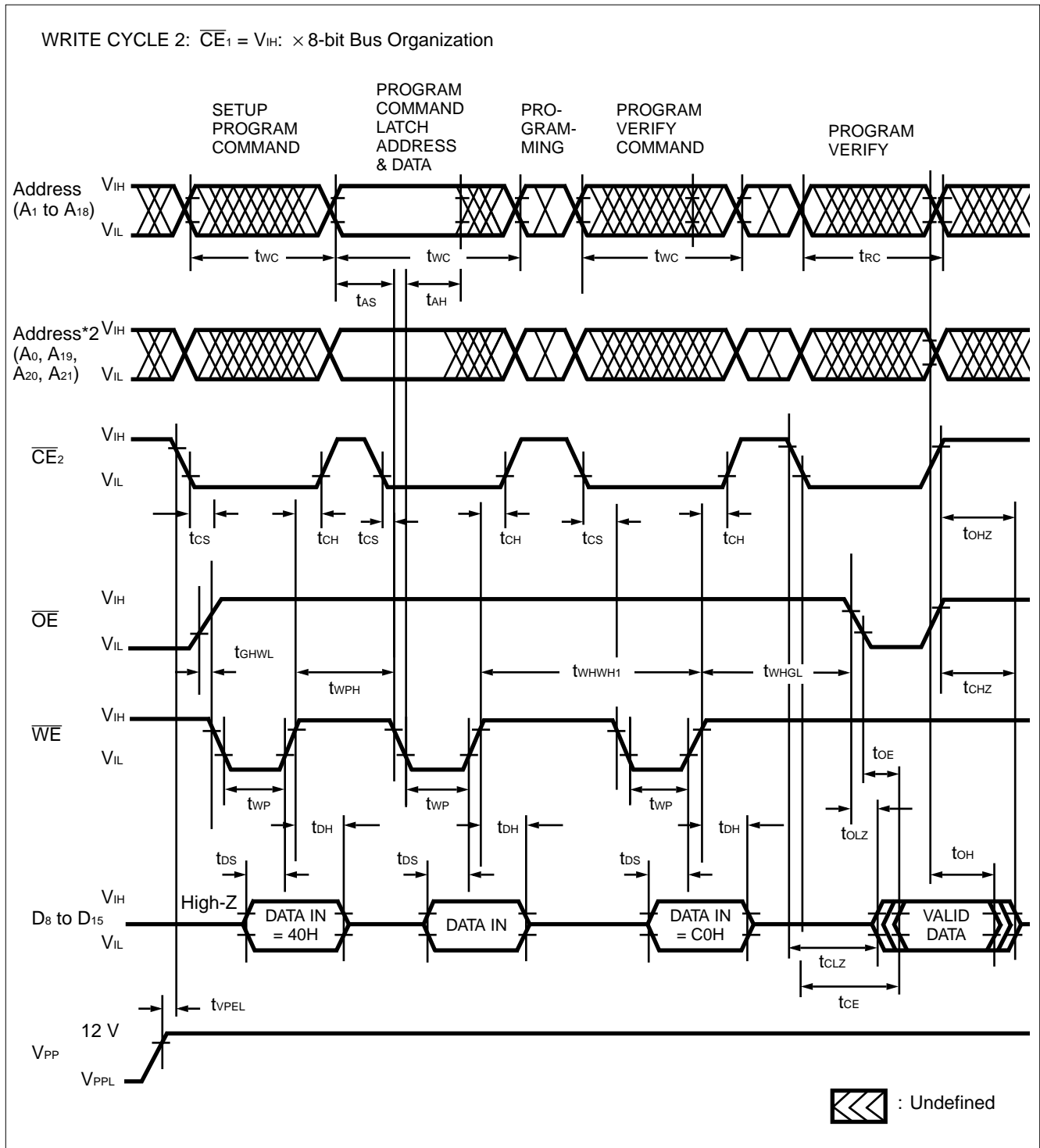

Notes: *1. A_0 , A_{19} , A_{20} and A_{21} have to be fixed during programming command input because these addresses are chip decoding addresses. Refer to the WRITE/ERASE CHIP DECODING INFORMATION.

*2. $A_0 = \text{Either } V_{IL} \text{ or } V_{IH}$.

MB98A809Bx-/810Bx-/811Bx-/812Bx-25

MAIN MEMORY WRITE CYCLE TIMING DIAGRAM (\overline{WE} = CONTROLLED) *1

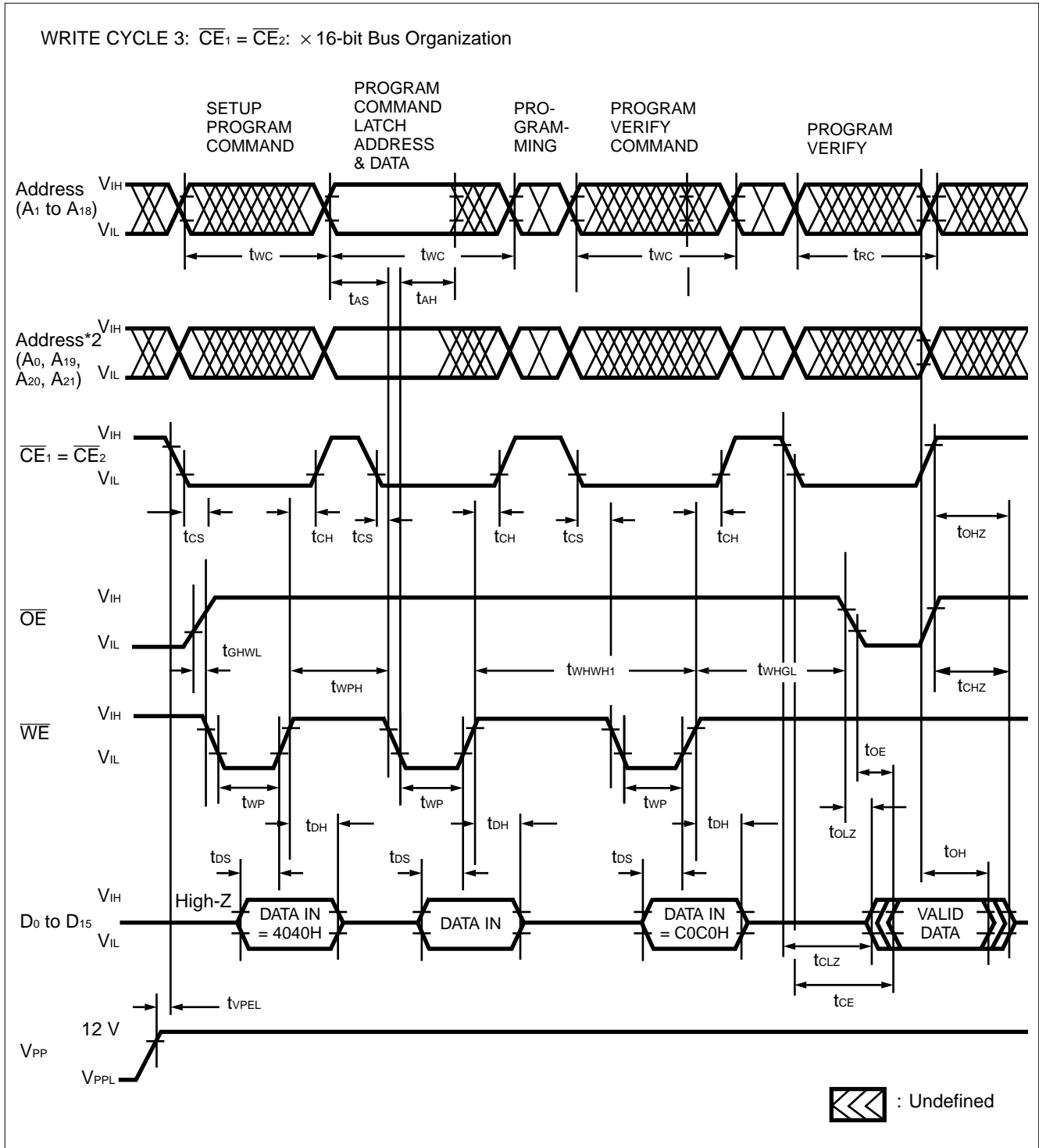

Notes: *1. A₀, A₁₉, A₂₀ and A₂₁ have to be fixed during programming command input because these addresses are chip decoding addresses. Refer to the WRITE/ERASE CHIP DECODING INFORMATION.

*2. A₀ = Either V_{IL} or V_{IH}.

MB98A809Bx-/810Bx-/811Bx-/812Bx-25

MAIN MEMORY WRITE CYCLE TIMING DIAGRAM ($\overline{CE} = \text{CONTROLLED}$) *1

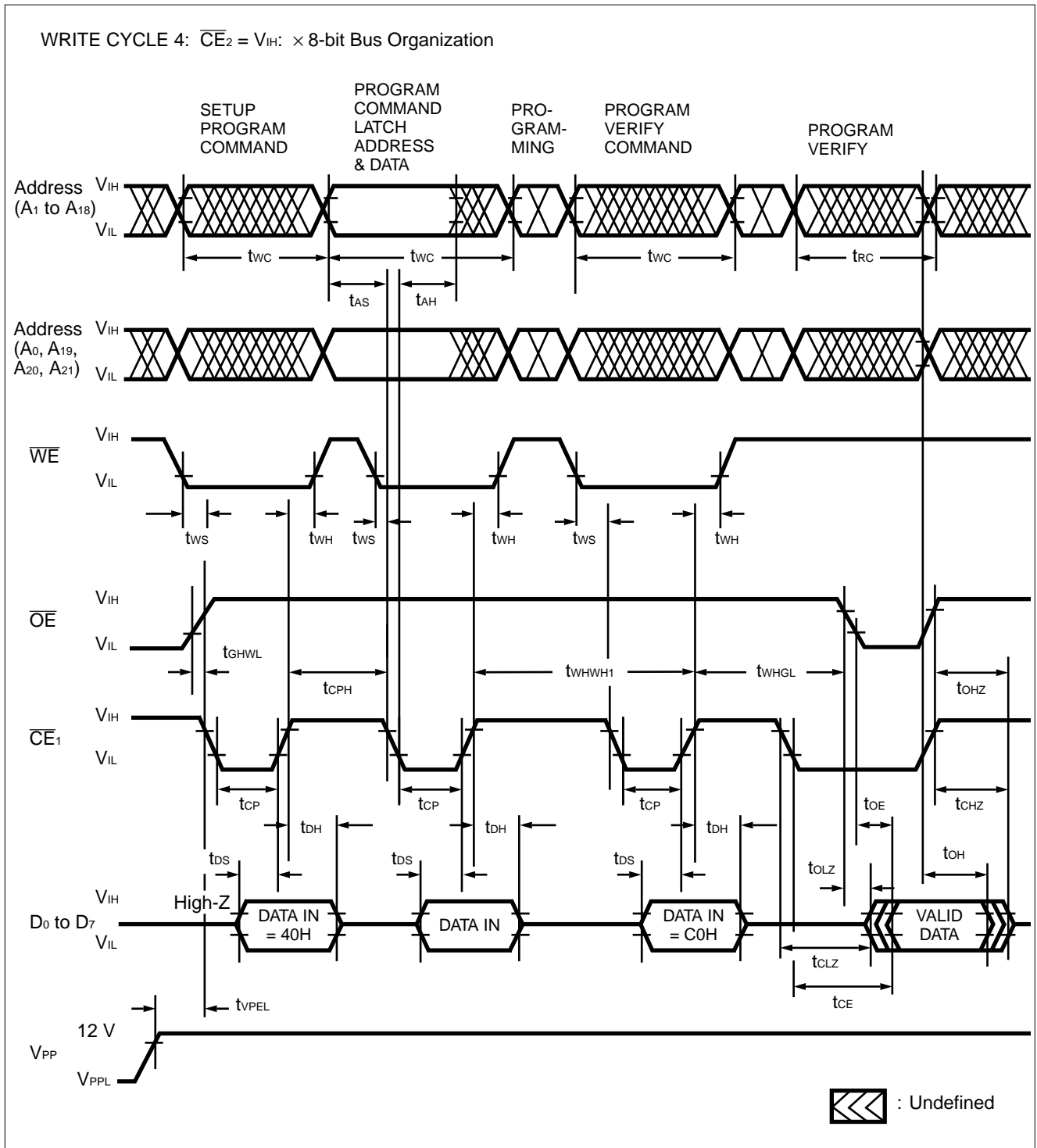

Note: *1. A_0 , A_{19} , A_{20} and A_{21} have to be fixed during programming command input because these addresses are chip decoding addresses. Refer to the WRITE/ERASE CHIP DECODING INFORMATION.

MB98A809Bx-/810Bx-/811Bx-/812Bx-25

MAIN MEMORY WRITE CYCLE TIMING DIAGRAM ($\overline{CE} = \text{CONTROLLED}$) *1

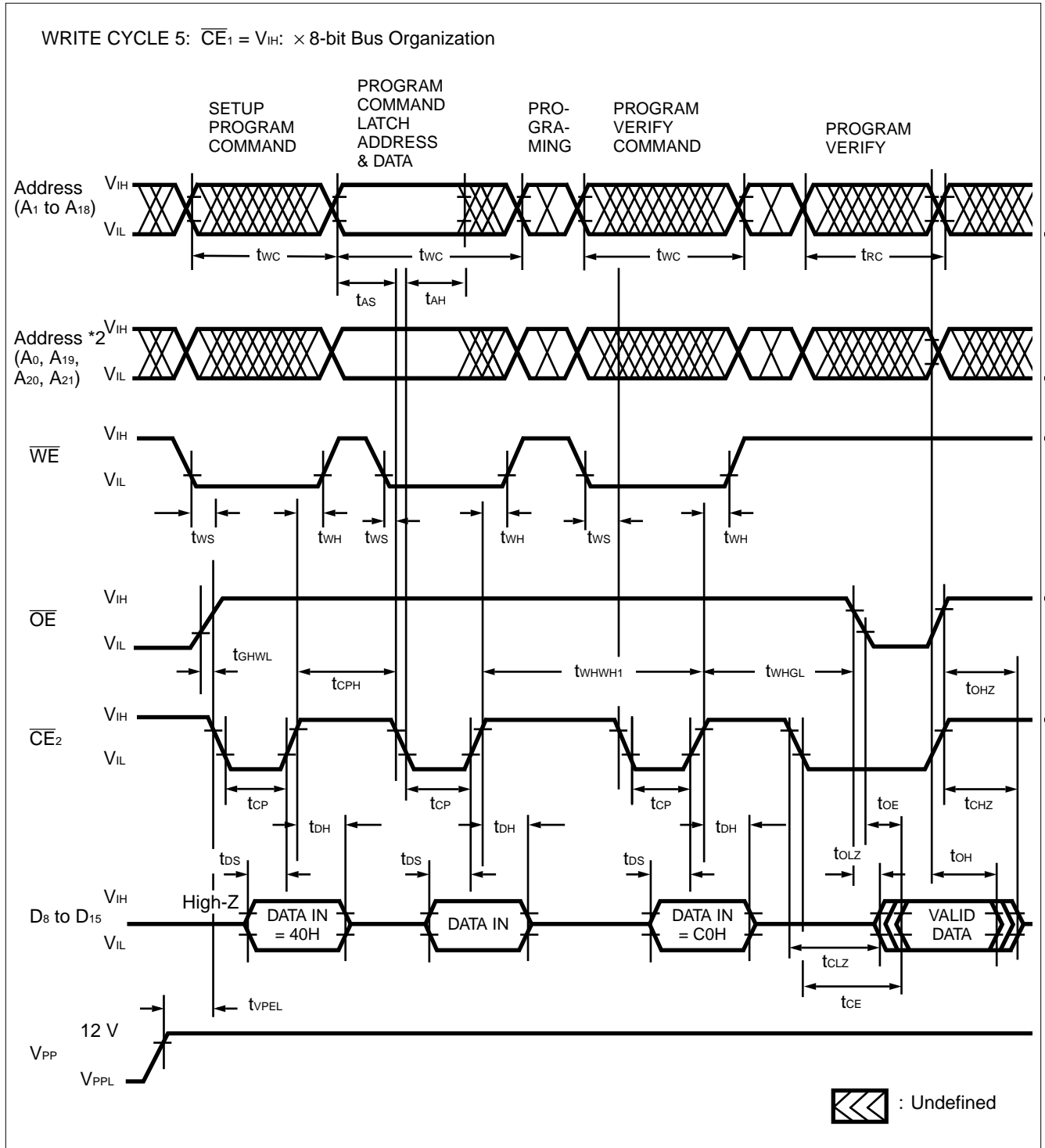

Notes: *1. A₀, A₁₉, A₂₀ and A₂₁ have to be fixed during programming command input because these addresses are chip decoding addresses. Refer to the WRITE/ERASE CHIP DECODING INFORMATION.

*2. A₀ = Either V_{IL} or V_{IH}.

MB98A809Bx-/810Bx-/811Bx-/812Bx-25

MAIN MEMORY ERASE CYCLE TIMING DIAGRAM (\overline{WE} = CONTROLLED) *1

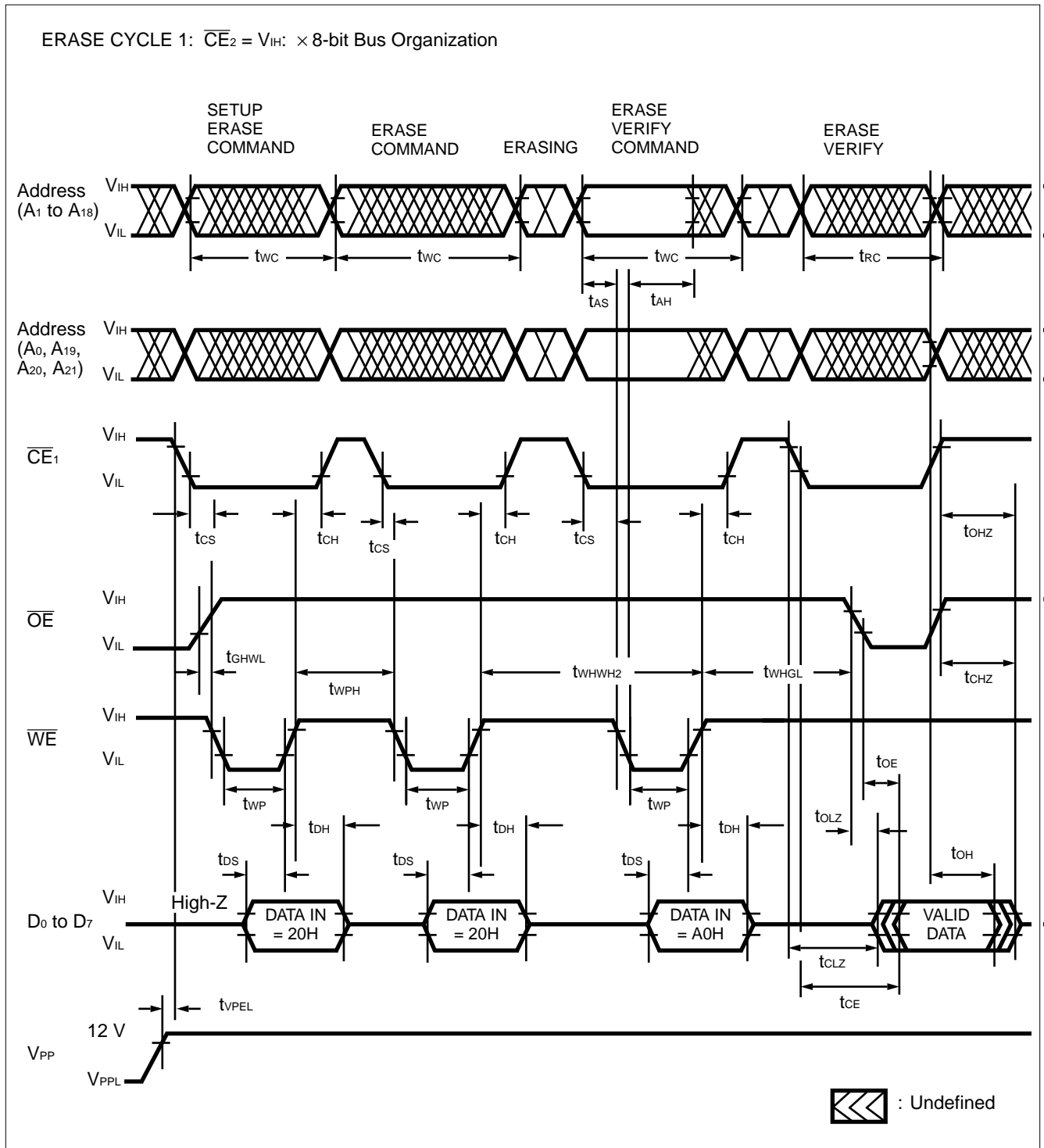

Note: *1. A_0 , A_{19} , A_{20} and A_{21} have to be fixed during erase command input because these addresses are chip decoding addresses. Refer to the WRITE/ERASE CHIP DECODING INFORMATION.

MB98A809Bx-/810Bx-/811Bx-/812Bx-25

MAIN MEMORY ERASE CYCLE TIMING DIAGRAM (\overline{WE} = CONTROLLED) *1

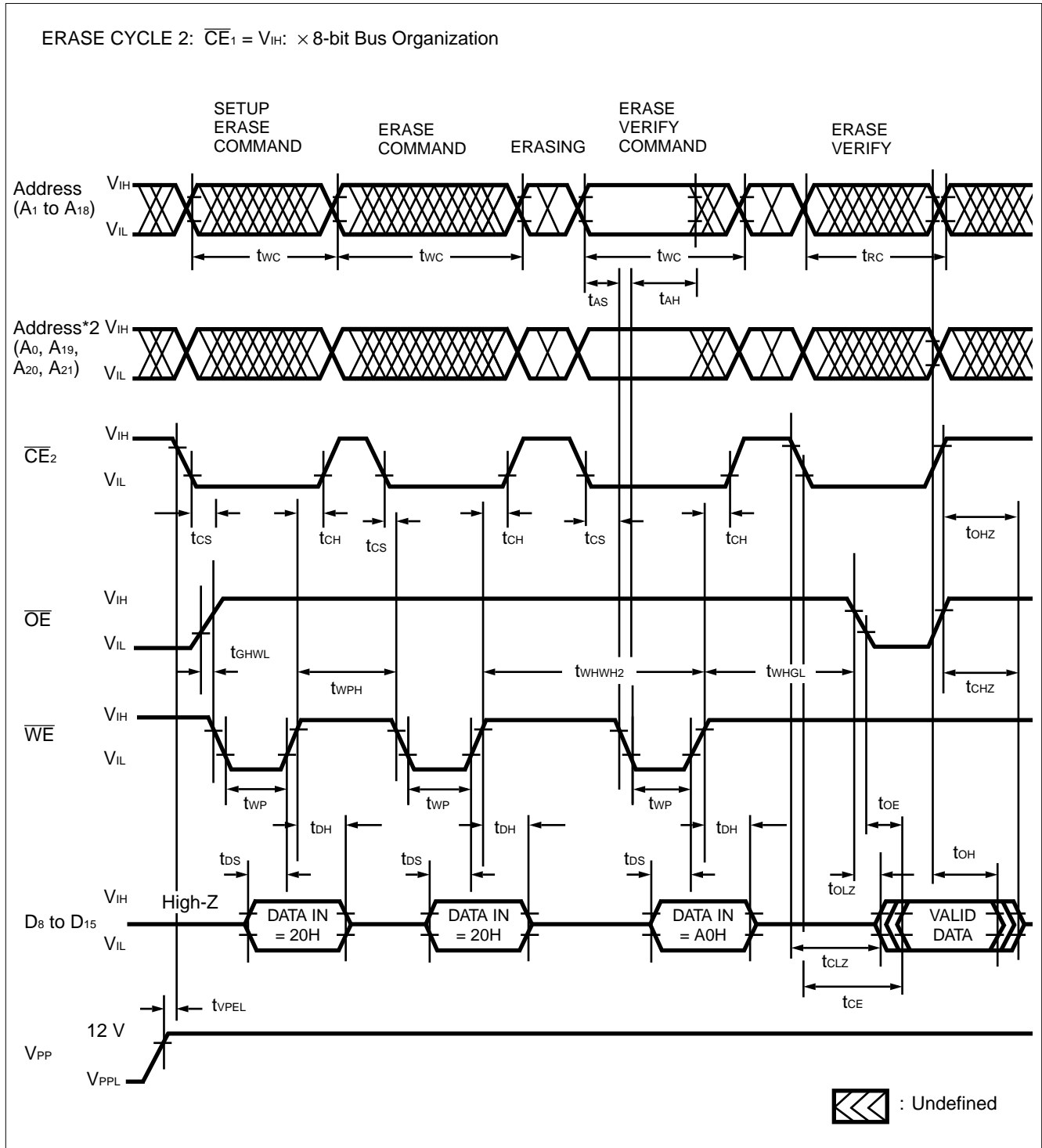

Notes: *1. A₀, A₁₉, A₂₀ and A₂₁ have to be fixed during erase command input because these addresses are chip decoding addresses. Refer to the WRITE/ERASE CHIP DECODING INFORMATION.

*2. A₀ = Either V_{IL} or V_{IH} .

MB98A809Bx-/810Bx-/811Bx-/812Bx-25

MAIN MEMORY ERASE CYCLE TIMING DIAGRAM (\overline{WE} = CONTROLLED) *1

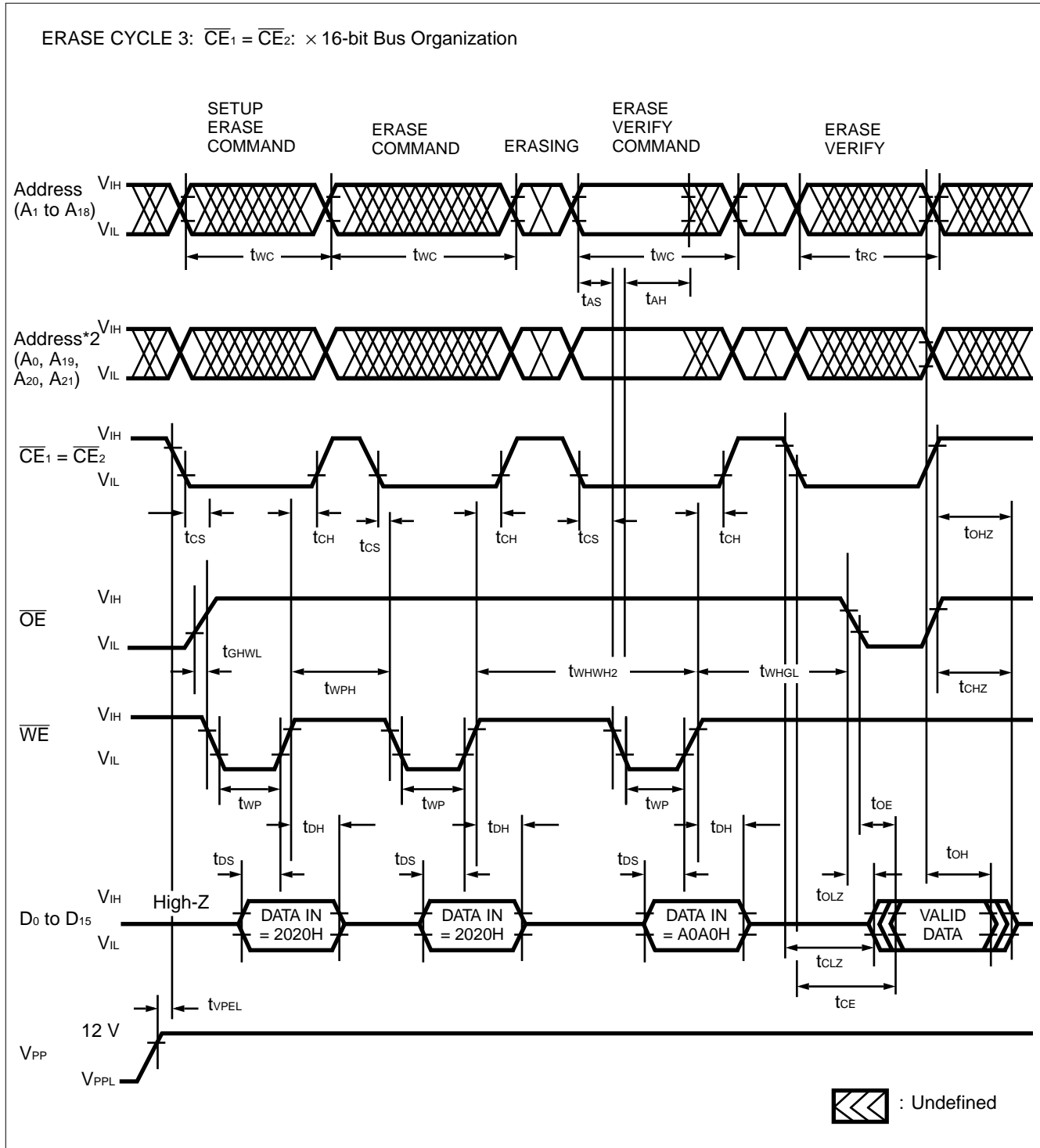

Notes: *1. A₀, A₁₉, A₂₀ and A₂₁ have to be fixed during erase command input because these addresses are chip decoding addresses. Refer to the WRITE/ERASE CHIP DECODING INFORMATION.

*2. A₀ = Either V_{IL} or V_{IH}.

MB98A809Bx-/810Bx-/811Bx-/812Bx-25

MAIN MEMORY ERASE CYCLE TIMING DIAGRAM ($\overline{CE} = \text{CONTROLLED}$) *1

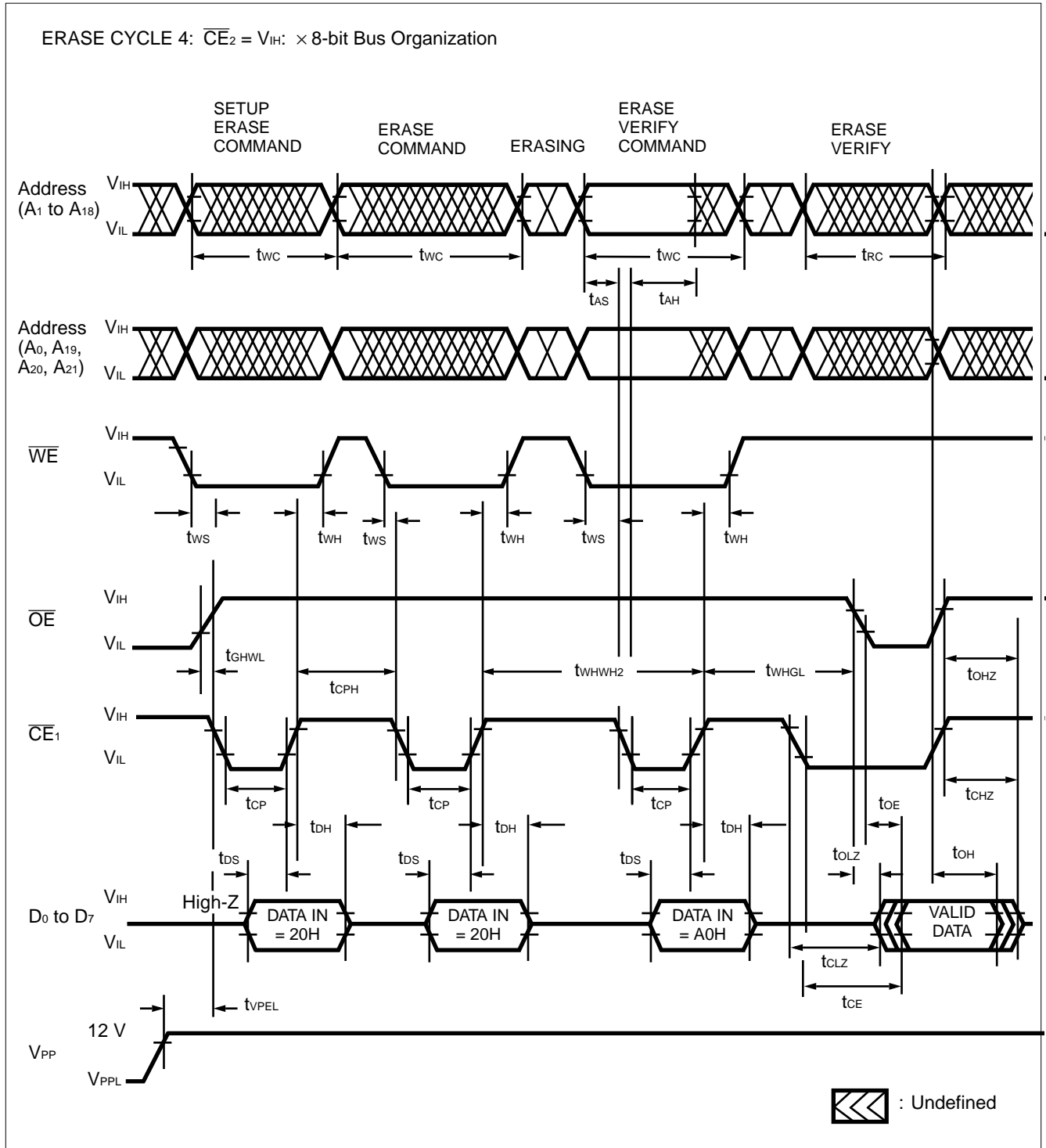

Note: *1. A_0 , A_{19} , A_{20} and A_{21} have to be fixed during erase command input because these addresses are chip decoding addresses. Refer to the WRITE/ERASE CHIP DECODING INFORMATION.

MB98A809Bx-/810Bx-/811Bx-/812Bx-25

MAIN MEMORY ERASE CYCLE TIMING DIAGRAM (\overline{CE} = CONTROLLED) *1

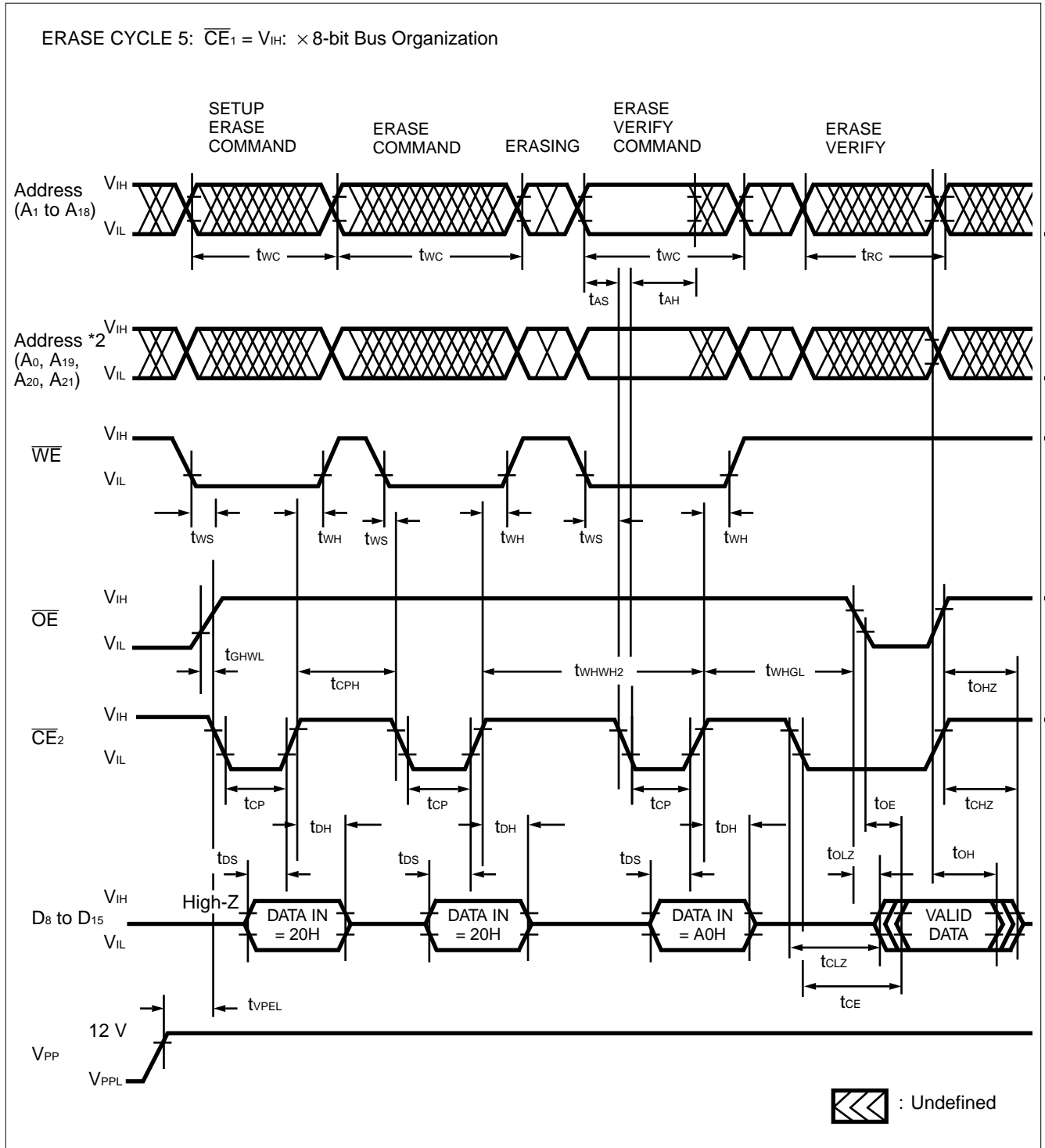

Notes: *1. A_0, A_{19}, A_{20} and A_{21} have to be fixed during erase command input because these addresses are chip decoding addresses. Refer to the WRITE/ERASE CHIP DECODING INFORMATION.

*2. $A_0 = \text{Either } V_{IL} \text{ or } V_{IH}$.

MB98A809Bx-/810Bx-/811Bx-/812Bx-25

ATTRIBUTE MEMORY WRITE CYCLE TIMING DIAGRAM (\overline{WE} = CONTROLLED, \overline{REG} = V_{IL}) *1

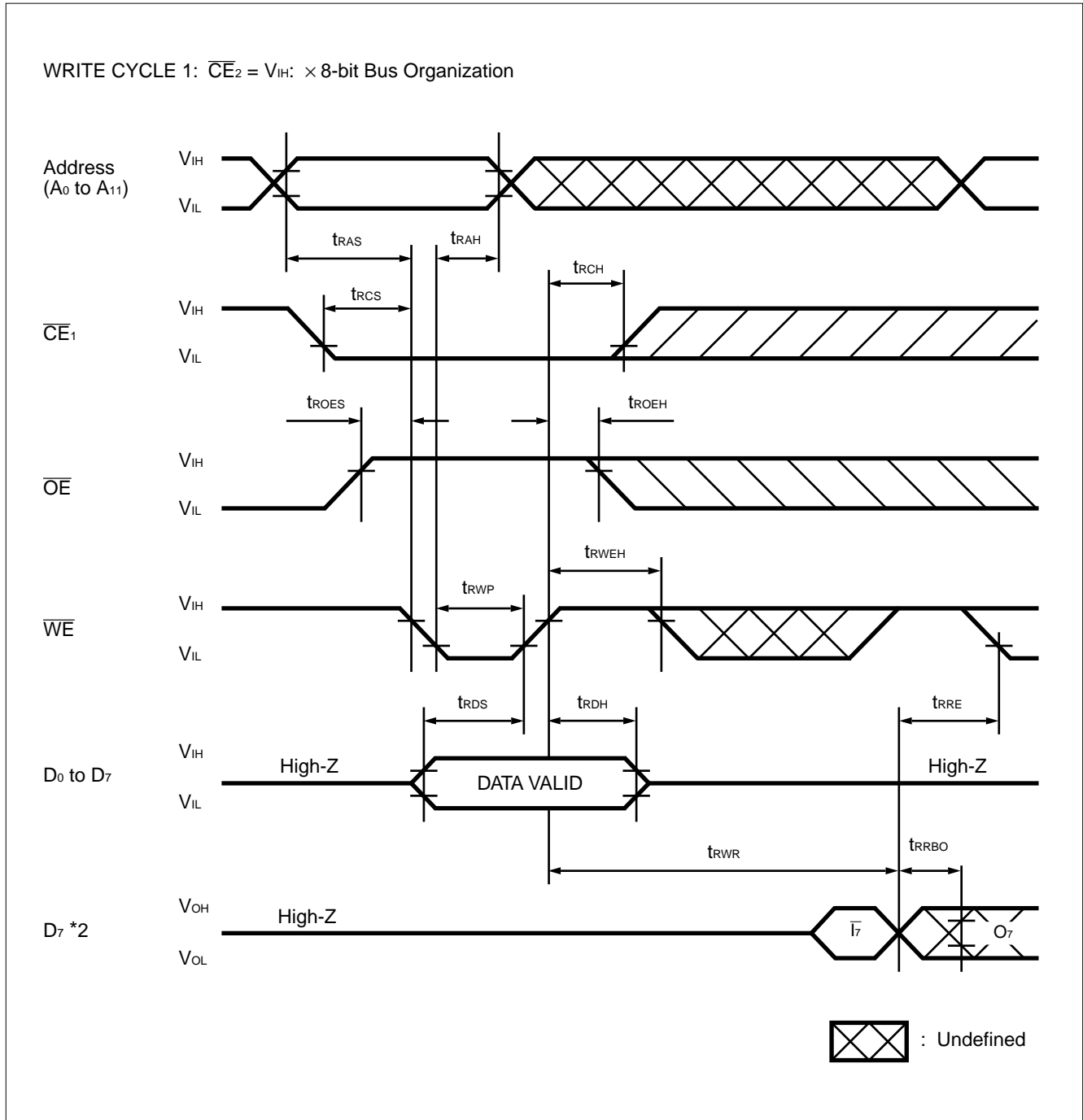

Notes: *1. This timing diagram is for MB98A809B3, 810B3, 811B3, and 812B3. "FF" data is available on MB98A809B2, 810B2, 811B2, and 812B2 only.

*2. Data polling operation.

MB98A809Bx-/810Bx-/811Bx-/812Bx-25

ATTRIBUTE MEMORY WRITE CYCLE TIMING DIAGRAM (\overline{WE} = CONTROLLED, \overline{REG} = V_{IL}) *1

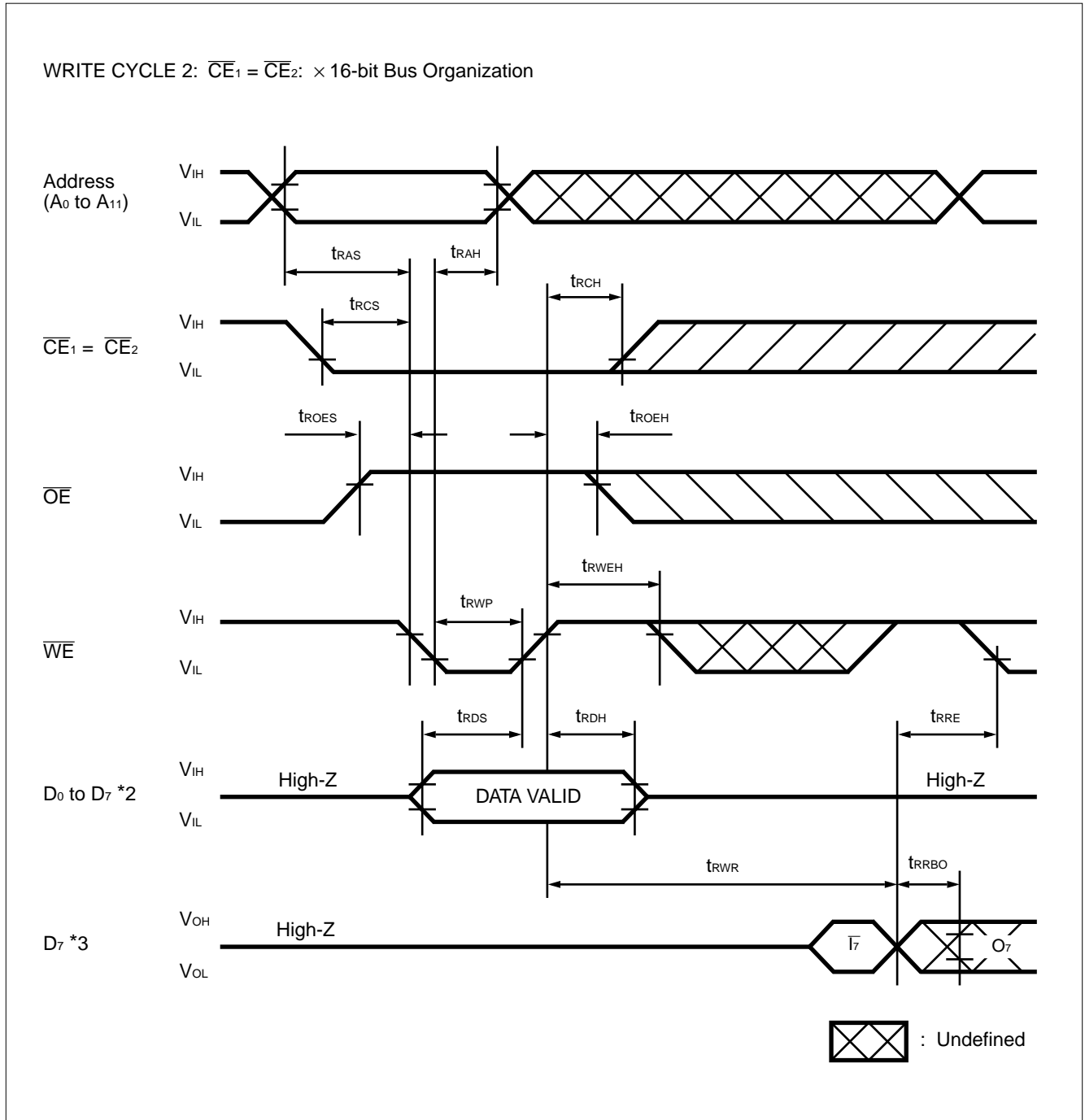

Notes: *1. This timing diagram is for MB98A809B3, 810B3, 811B3, and 812B3. "FF" data is available on MB98A809B2, 810B2, 811B2, and 812B2 only.

*2. H-level or L-level is output from D₈ to D₁₅.

*3. Data polling operation.

MB98A809Bx-/810Bx-/811Bx-/812Bx-25

ATTRIBUTE MEMORY WRITE CYCLE TIMING DIAGRAM ($\overline{CE} = \text{CONTROLLED}$, $\overline{REG} = V_{IL}$) *1

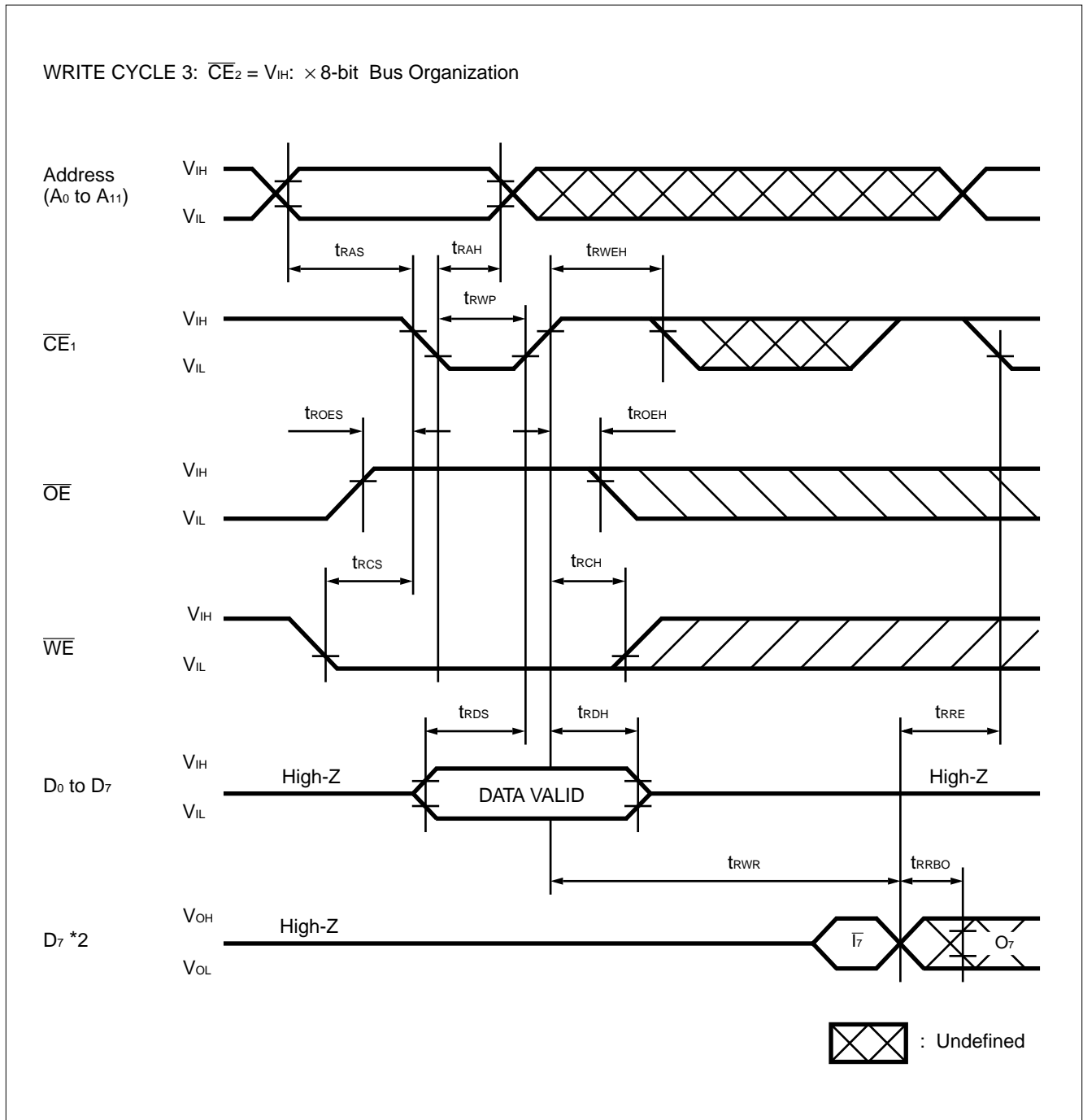

Notes: *1. This timing diagram is for MB98A809B3, 810B3, 811B3, and 812B3. "FF" data is available on MB98A809B2, 810B2, 811B2, and 812B2 only.

*2. Data polling operation.

MB98A809Bx-/810Bx-/811Bx-/812Bx-25

WRITE/ERASE INFORMATION

Fig. 4 – WRITE FLOWCHART FOR 8-BIT ORGANIZATION

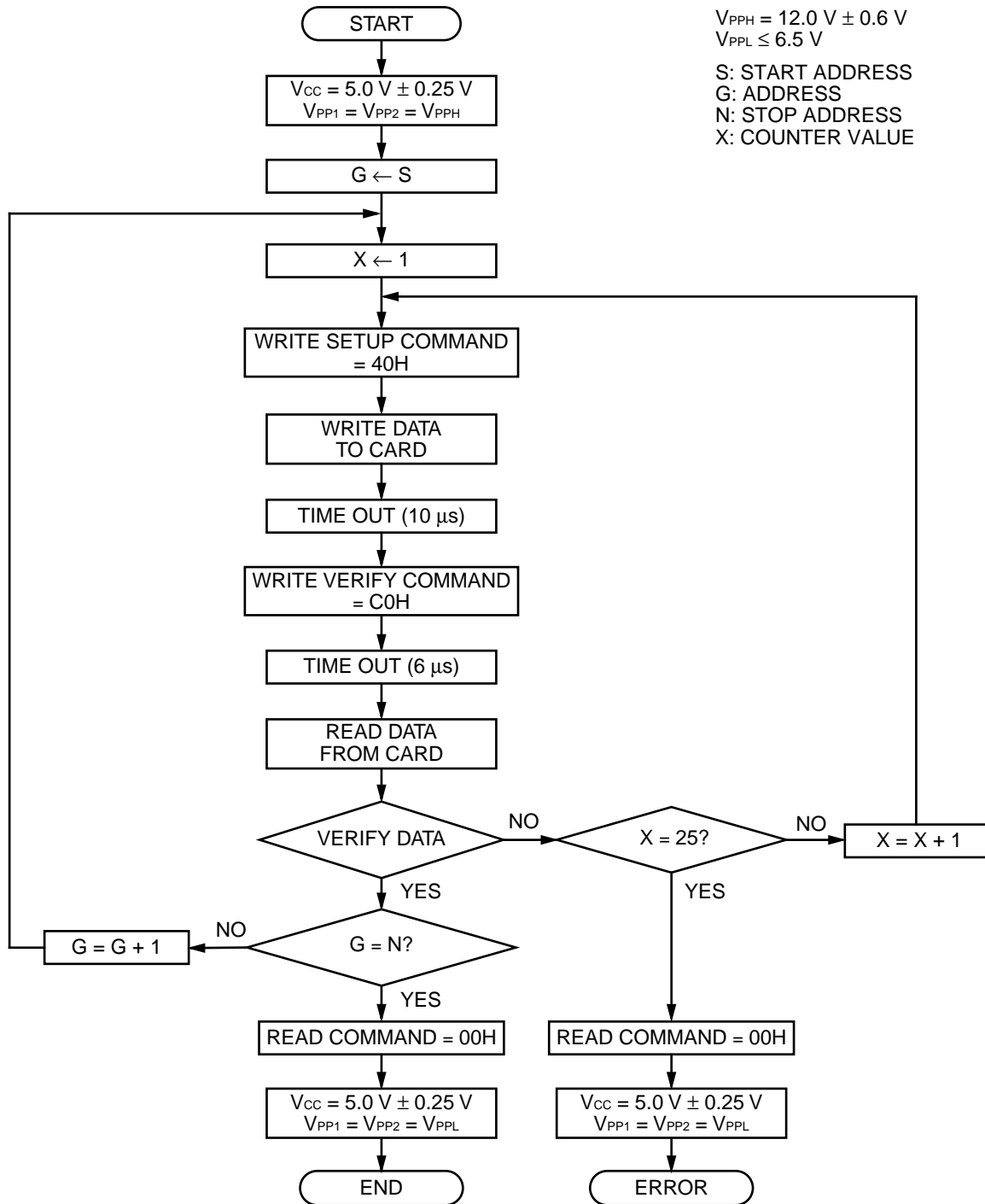

MB98A809Bx-/810Bx-/811Bx-/812Bx-25

Fig. 5 – WRITE FLOWCHART FOR 16-BIT ORGANIZATION

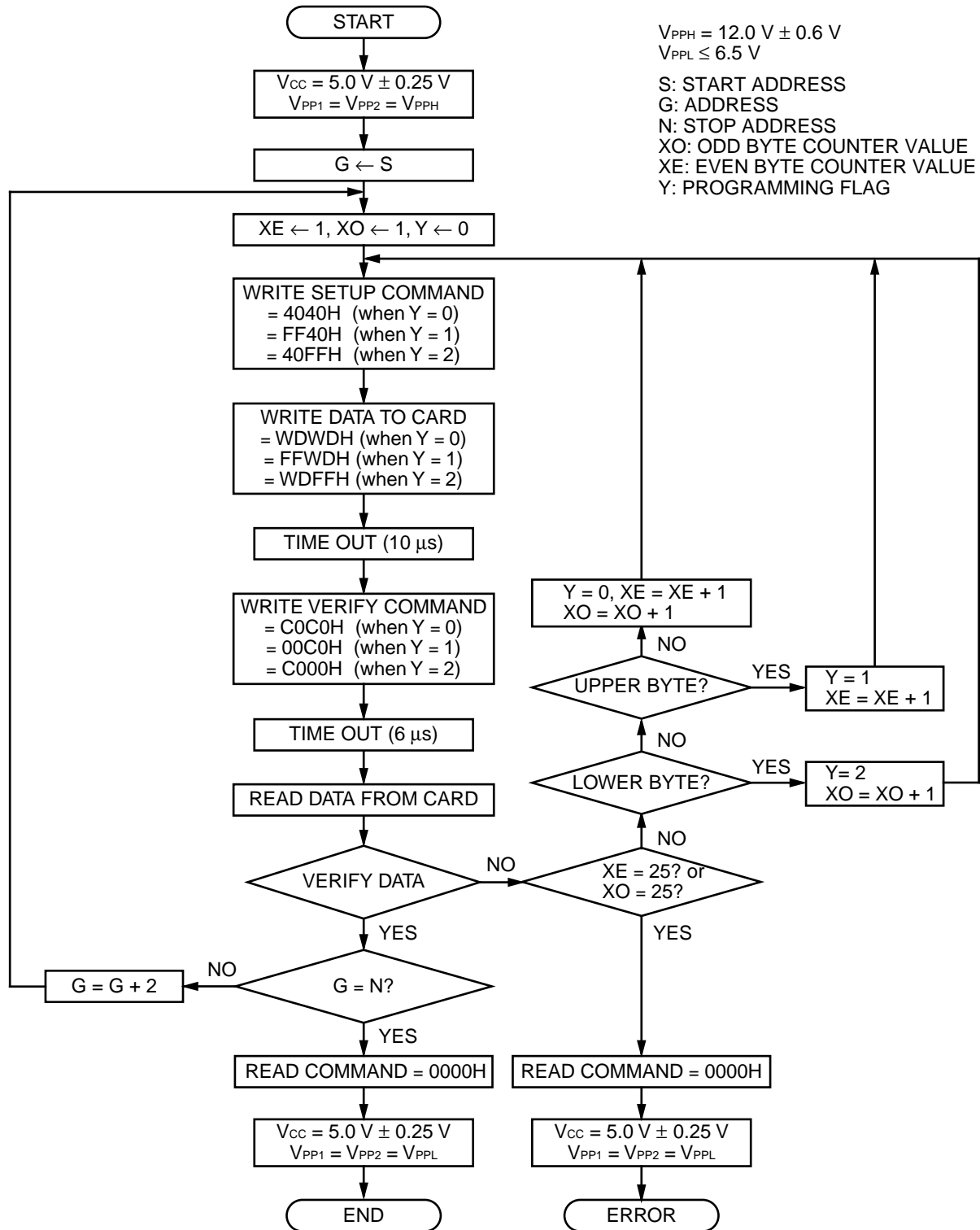

MB98A809Bx-/810Bx-/811Bx-/812Bx-25

Fig. 6 – ERASE FLOWCHART FOR 8-BIT ORGANIZATION

$V_{PPH} = 12.0\text{ V} \pm 0.6\text{ V}$
 $V_{PPL} \leq 6.5\text{ V}$

G: ADDRESS
 N1: LOWER BYTE END ADDRESS
 N2: UPPER BYTE END ADDRESS
 X: COUNTER VALUE

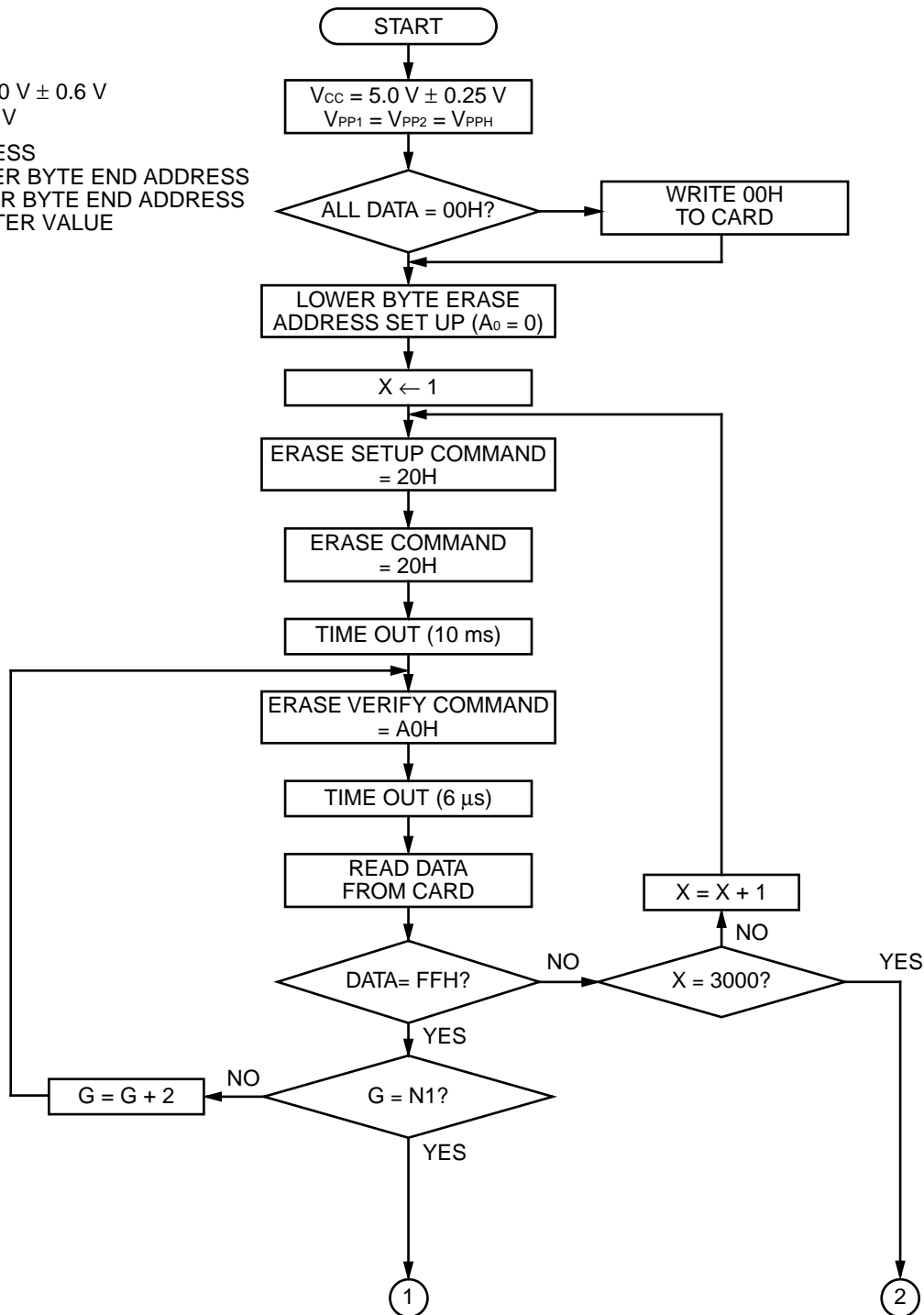

(Continued on page 41.)

(Continued on page 41.)

MB98A809Bx-/810Bx-/811Bx-/812Bx-25

Fig. 7 – ERASE FLOWCHART FOR 8-BIT ORGANIZATION (Continued)

$V_{PPH} = 12.0\text{ V} \pm 0.6\text{ V}$
 $V_{PPL} \leq 6.5\text{ V}$

G: ADDRESS
 N1: LOWER BYTE END ADDRESS
 N2: UPPER BYTE END ADDRESS
 X: COUNTER VALUE

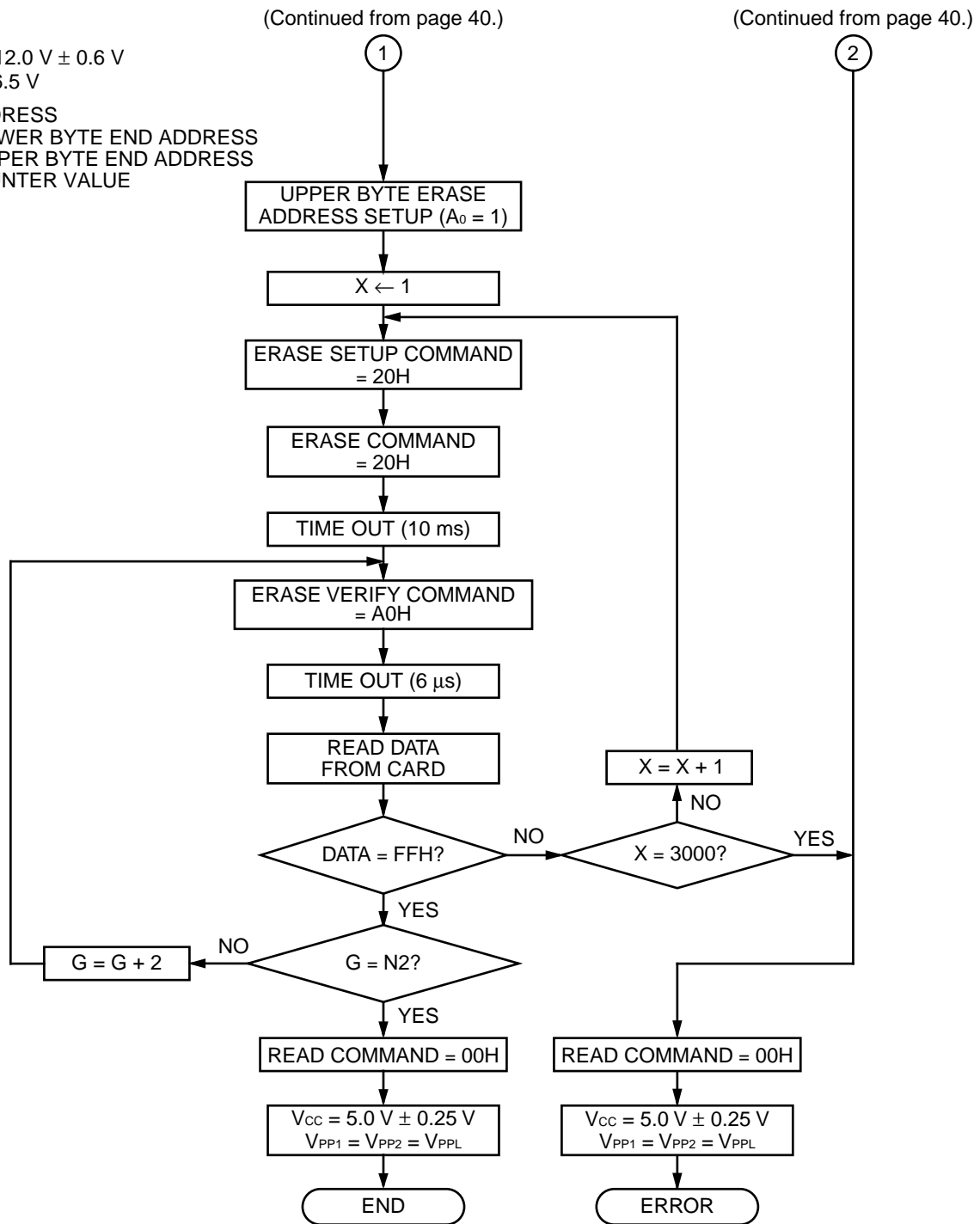

MB98A809Bx-/810Bx-/811Bx-/812Bx-25

Fig. 8 – ERASE FLOWCHART FOR 16-BIT ORGANIZATION

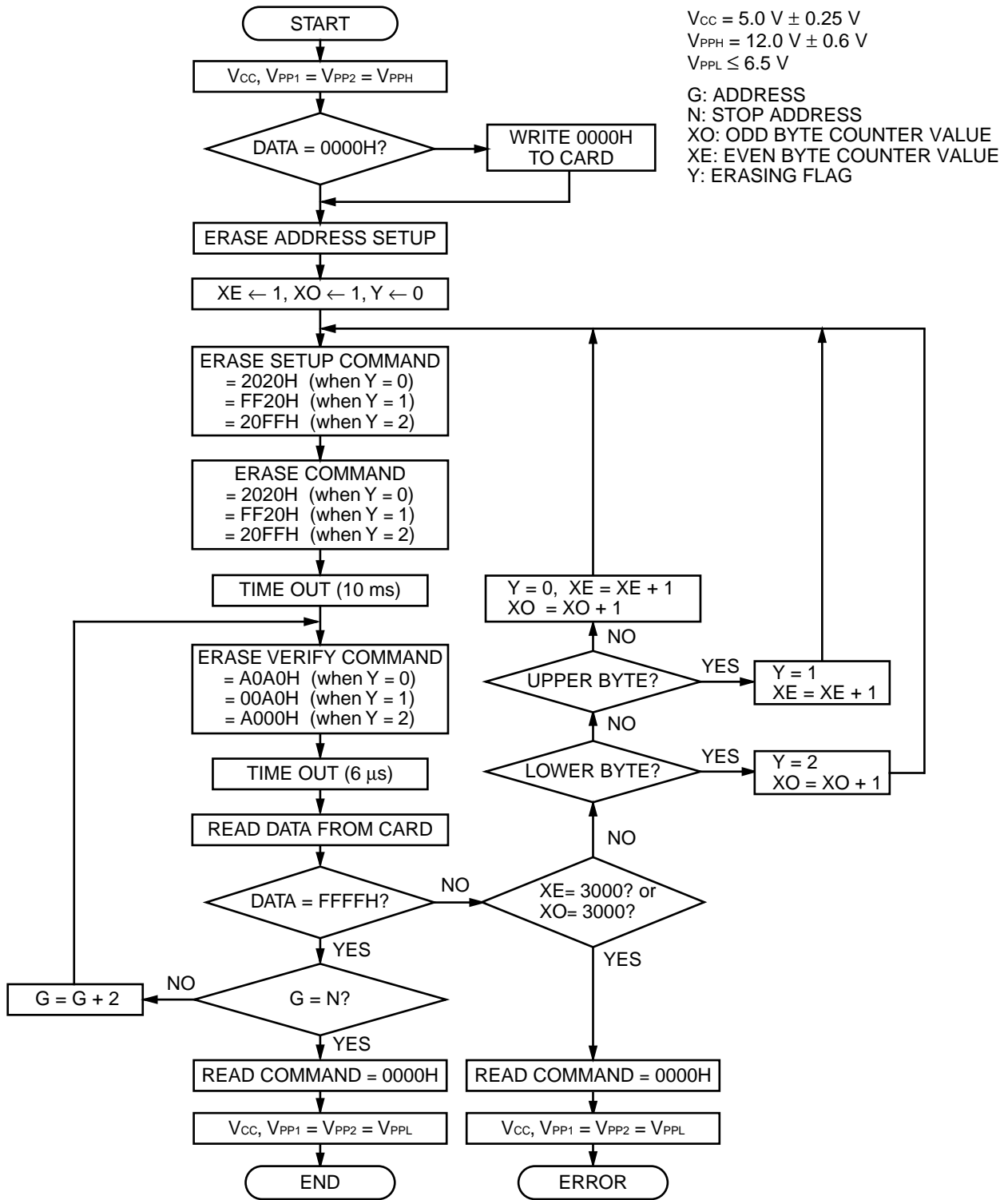

MB98A809Bx-/810Bx-/811Bx-/812Bx-25

■ UNIQUE FEATURES FOR FLASH MEMORY CARD

1. SPECIAL MONITORING PINS

1.1 \overline{CD}_1 , \overline{CD}_2 : Card Detection Pins

These pins detect the insertion of the card into the system. (See Fig. 9.)
When the memory card has been correctly inserted, \overline{CD}_1 and \overline{CD}_2 are detected by the system. \overline{CD}_1 , \overline{CD}_2 are tied to ground on the card side as shown in Fig. 9.

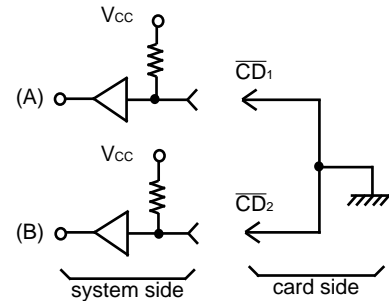

– Fig. 9 –

1.2 WP: Write Protect Pins

This pin monitors the position of the Write Protect switch. As shown in Fig. 10, the Flash memory card has a Write Protect switch at the top of the card.

To write to the card, the switch must be turned to the “Non Protect” position and the \overline{WE} pin low. L-level is output on the WP pin.

To prevent writing to the card, the switch must be turned to the “Protect” position. H-level is output on the WP pin.

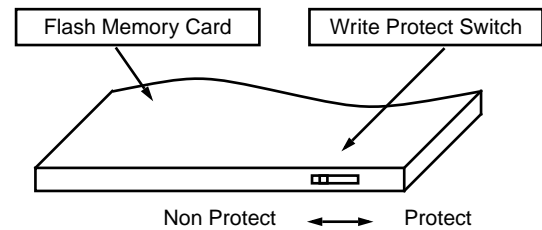

– Fig. 10 –

WP Switch	WP (output)
Protect	H
Non Protect	L

■ DEVICE HANDLING PRECAUTIONS

This device is composed of fine electronic parts, so take care in handling or keeping it as below.

- The card is made fine, so do not keep it in the high temperature nor high humidity, place like in the direct sunshine nor near the heater.
- The card should not be bent, scratched, dropped nor be shocked violently.
- This device should never be taken apart. It could destroy the card or your personal computer hardware.
- To help you handle this device safely, request us the device specifications when purchasing this device.

MB98A809Bx-/810Bx-/811Bx-/812Bx-25

■ PACKAGE DIMENSIONS

68-PIN MEMORY CARD
(CASE No.: CRD-68P-M17)

Dimensions conform with PCMCIA/JEIDA (PC CARD STANDARD 95)

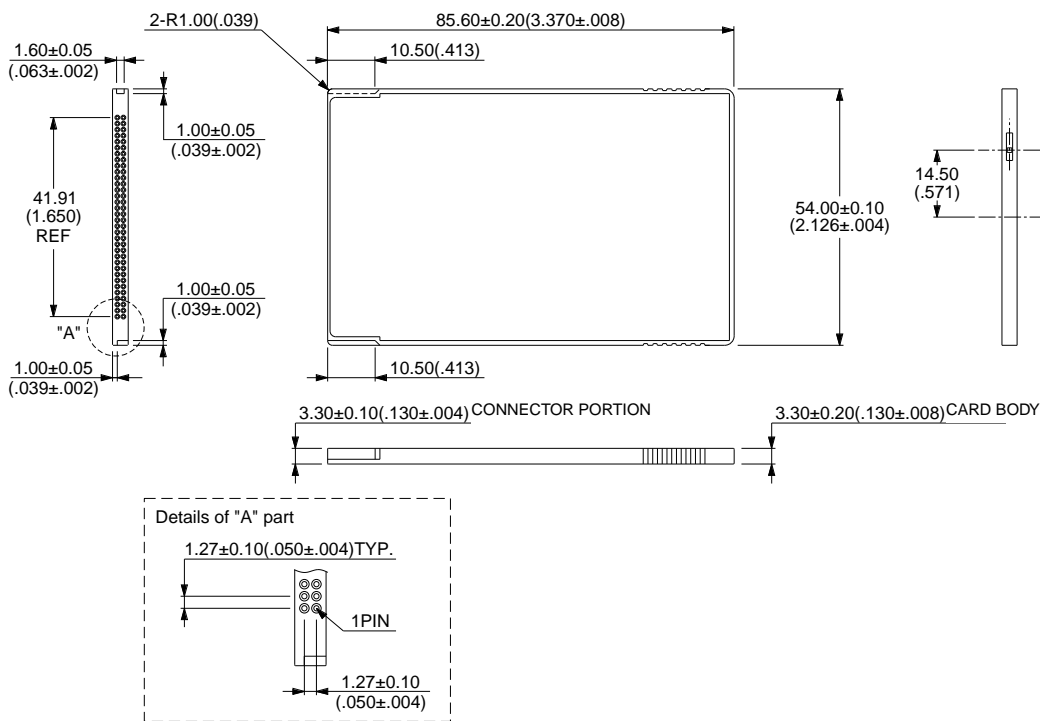

MB98A809Bx-/810Bx-/811Bx-/812Bx-25

FUJITSU LIMITED

For further information please contact:

Japan

FUJITSU LIMITED
Corporate Global Business Support Division
Electronic Devices
KAWASAKI PLANT, 4-1-1, Kamikodanaka
Nakahara-ku, Kawasaki-shi
Kanagawa 211-88, Japan
Tel: (044) 754-3763
Fax: (044) 754-3329

North and South America

FUJITSU MICROELECTRONICS, INC.
Semiconductor Division
3545 North First Street
San Jose, CA 95134-1804, U.S.A.
Tel: (408) 922-9000
Fax: (408) 432-9044/9045

Europe

FUJITSU MIKROELEKTRONIK GmbH
Am Siebenstein 6-10
63303 Dreieich-Buchsschlag
Germany
Tel: (06103) 690-0
Fax: (06103) 690-122

Asia Pacific

FUJITSU MICROELECTRONICS ASIA PTE. LIMITED
#05-08, 151 Lorong Chuan
New Tech Park
Singapore 556741
Tel: (65) 281-0770
Fax: (65) 281-0220

All Rights Reserved.

The contents of this document are subject to change without notice. Customers are advised to consult with FUJITSU sales representatives before ordering.

The information and circuit diagrams in this document presented as examples of semiconductor device applications, and are not intended to be incorporated in devices for actual use. Also, FUJITSU is unable to assume responsibility for infringement of any patent rights or other rights of third parties arising from the use of this information or circuit diagrams.

FUJITSU semiconductor devices are intended for use in standard applications (computers, office automation and other office equipment, industrial, communications, and measurement equipment, personal or household devices, etc.).

CAUTION:

Customers considering the use of our products in special applications where failure or abnormal operation may directly affect human lives or cause physical injury or property damage, or where extremely high levels of reliability are demanded (such as aerospace systems, atomic energy controls, sea floor repeaters, vehicle operating controls, medical devices for life support, etc.) are requested to consult with FUJITSU sales representatives before such use. The company will not be responsible for damages arising from such use without prior approval.

Any semiconductor devices have inherently a certain rate of failure. You must protect against injury, damage or loss from such failures by incorporating safety design measures into your facility and equipment such as redundancy, fire protection, and prevention of over-current levels and other abnormal operating conditions.

If any products described in this document represent goods or technologies subject to certain restrictions on export under the Foreign Exchange and Foreign Trade Control Law of Japan, the prior authorization by Japanese government should be required for export of those products from Japan.